

2016 Owner's Manual

United States and Canada

Cal Spas®
LUXURY RESORT LIVING FOR EVERYONE

Patio
Patio Plus
Escape
Escape Plus
Special Edition



© 2016 LMS

www.calspas.com

Cal Spas Home Resort™

Table of Contents

Important Safety Instructions	1	Generic Names for Chemicals	29
Preparing for Your New Portable Spa . 2		Common Water Chemistry Questions	30
Pre-Delivery Checklist	2	Do's and Don'ts	31
Planning the Best Location	2	Bather Load	32
Preparing a Good Foundation	3	Pure Cure™ Water Sanitizer	32
240 Volt Electrical Installation	3	Ozonator	32
Wiring Requirement/GFCI Wiring Diagram	4	Troubleshooting Water Clarity Problems	33
120 Volt Electrical Installation	5	Bromine Generator	34
Testing the 240 Volt GFCI Breaker	5	Intelligent Controller Codes for the Bromine Generator	35
Filling and Powering Up Your Portable Spa	5	Cleaning and Maintenance	36
Priming the Pump	8	Removing and Reseating the Pillows	36
Operating Your Spa	9	Jet Removal and Replacement	36
TP400 and TP600 Control Panel Operation . 9		Draining Your Portable Spa	37
Cal Spas Hot Tub Wi-Fi App	18	Winterizing (Cold Climate Draining)	38
Microsilk Therapy System	20	Cleaning and Replacing the Filter	38
Cloud Service	20	Spa Cover	39
Jets	20	Vacation Care	39
LED Perimeter Lighting	21	Cleaning Your Spa	39
Aquatic Air Therapy™ (AAT)	21	Changing the UV Lamp	40
Diverter Knobs	22	Using the Digital Media Locker	41
Air Venturis	22	Aquatic AV AQ-DM-5UBT	41
Waterfalls	22	Using the Freedom Sound System	44
Hydro Streamer Waterfall	22	Appendix	45
Water Clarity	23	Replacement Parts	45
Water Quality Terms and Definitions	23	Basic Troubleshooting	53
Water Testing Methods	24	Limited Warranty	56
Adding Chemicals To The Spa Water	25	Warranty Registration	58
1. Balancing the Water Chemistry Levels . 25			
2. Sanitation and Shock	27		
3. Filtration	28		
4. Regularity (Maintenance Schedule)	29		

Copyright 2016 LMS. All rights reserved. Duplication without written consent is strictly prohibited.

Cal Spas®, Pure Cure™, and Freedom Sound System™ are registered trademarks.

Due to continuous improvement programs, all models, operation, and/or specifications are subject to change without prior notice.

LTR20161000, Rev. H
8/16/16

100-1457

CONTACT INFORMATION

For customer service, please contact your authorized dealer immediately. If you need additional information and/or assistance, contact:

LMS Customer Service Department
1462 East Ninth Street
Pomona, CA 91766.

Toll Free: 1-800-CAL-SPAS
Fax: 1-909-629-3890

Important Safety Instructions

READ AND FOLLOW ALL INSTRUCTIONS.

DANGER -- Risk of accidental drowning:

Do not allow children to be in or around a spa unless a responsible adult supervises them. Keep the spa cover on and locked when not in use. See instructions enclosed with your cover for locking procedures.

DANGER -- Risk of injury:

The suction fittings in this spa are sized to match the specific water flow created by the pump. Should the need arise to replace the suction fittings, or the pump, be sure the flow rates are compatible.

Never operate the spa if the suction fitting or filter baskets are broken or missing. Never replace a suction fitting with one that is rated less than the flow rate marked on the original suction fitting.

DANGER -- Risk of electric shock:

Install the spa at least 5 feet (1.5 meters) from all metal surfaces. As an alternative, a spa may be installed within 5 feet of metal surfaces if each metal surface is permanently bonded by a minimum #8 AWG solid copper conductor to the outside of the spa's control box.

Do not permit any external electrical appliances, such as lights, telephones, radios, televisions, and etc., within five feet (1.5 meters) of the spa. Never attempt to operate any electrical device from inside the spa.

Replace a damaged power cord immediately.

Do not bury the power cord.

Connect to a grounded, grounding-type receptacle only.

WARNING -- To reduce the risk of injury:

The spa water should never exceed 104°F (40°C). Water temperatures between 100°F (38°C) and 104°F (40°C) are considered safe for a healthy adult. Lower water temperatures are recommended for young children and when spa use exceeds 10 minutes.

High water temperatures have a high potential for causing fetal damage during pregnancy. Women who are pregnant, or who think they are pregnant, should always check with their physician prior to spa usage.

The use of alcohol, drugs or medication before or during

spa use may lead to unconsciousness, with the possibility of drowning.

Persons suffering from obesity, a medical history of heart disease, low or high blood pressure, circulatory system problems or diabetes should consult a physician before using the spa.

Persons using medications should consult a physician before using the spa since some medications may induce drowsiness while others may affect heart rate, blood pressure and circulation.

HYPERTHERMIA DANGER:

Prolonged exposure to hot air or water can induce hyperthermia. Hyperthermia occurs when the internal temperature of the body reaches a level 3°F to 6°F above the normal body temperature of 98.6°F (or 2°C to 4°C above 37°C). While hyperthermia has many health benefits, it is important not to allow your body's core temperature to rise above 103°F (39.5°C).

Symptoms of excessive hyperthermia include dizziness, lethargy, drowsiness and fainting. The effects of excessive hyperthermia may include:

- Failure to perceive heat
- Failure to recognize the need to exit spa or hot tub
- Unawareness of impending hazard
- Fetal damage in pregnant women
- Physical inability to exit the spa
- Unconsciousness

WARNING: The use of alcohol, drugs, or medication can greatly increase the risk of fatal hyperthermia.

WARNING: People with infectious diseases should not use a spa or hot tub.

WARNING: To avoid injury, exercise care when entering or exiting the spa or hot tub.

WARNING: Do not use drugs or alcohol before or during the use of a spa or hot tub to avoid unconsciousness and possible drowning.

WARNING: Do not use a spa or hot tub immediately following strenuous exercise.

WARNING: Prolonged immersion in a spa or hot tub may be injurious to your health.

CAUTION: Maintain water chemistry in accordance with manufacturer's instructions.

SAVE THESE INSTRUCTIONS.

Preparing for Your New Portable Spa

Pre-Delivery Checklist

Most cities and counties require permits for exterior construction and electrical circuits. In addition, some communities have codes requiring residential barriers such as fencing and/or self-closing gates on property to prevent unsupervised access to the property by children. Your dealer can provide information on which permits may be required and how to obtain them prior to the delivery of your spa.

Before Delivery	
	Plan your delivery route
	Choose a suitable location for the spa
	Lay a 5 - 8 cm concrete slab
	Install dedicated electrical supply
After Delivery	
	Place spa on slab
	Connect electrical components

Planning the Best Location

Safety First

Do not place your spa within 10 feet (3 m) of overhead power lines.

Consider How You Will Use Your Spa

How you intend to use your spa will help you determine where you should position it. For example, will you use your spa for recreational or therapeutic purposes? If your spa is mainly used for family recreation, be sure to leave plenty of room around it for activity. If you will use it for relaxation and therapy, you will probably want to create a specific mood around it.

Plan for Your Environment

If you live in a region where it snows in the winter or rains frequently, place the spa near a house entry. By doing this, you will have a place to change clothes and not be uncomfortable.

Consider Your Privacy

In a cold-weather climate, bare trees won't provide much privacy. Think of your spa's surroundings during all seasons to determine your best privacy options. Consider the view of your neighbors as well when you plan the location of your spa.

Provide a View with Your Spa

Think about the direction you will be facing when sitting in your spa. Do you have a special landscaped area in your yard that you find enjoyable? Perhaps there is an area that catches a soothing breeze during the day or a lovely sunset in the evening.

Keep Your Spa Clean

In planning your spa's location, consider a location where the path to and from the house can be kept clean and free of debris.

Prevent dirt and contaminants from being tracked into your spa by placing a foot mat at the spa's entrance where the bathers can clean their feet before entering your spa.

Allow for Service Access

Make sure the spa is positioned so that access to the equipment compartment and all side panels will not be blocked.

Many people choose to install a decorative structure around their spa. If you are installing your spa with any type of structure on the outside, such as a gazebo, remember to allow access for service. It is always best to design special installations so that the spa can still be moved, or lifted off the ground.

Preparing a Good Foundation

Your spa needs a solid and level foundation. The area that it sits on must be able to support the weight of the spa, with water and the occupants who use it. If the foundation is inadequate, it may shift or settle after the spa is in place, causing stress that could DAMAGE YOUR SPA SHELL AND FINISH.

Damage caused by inadequate or improper foundation support is not covered by the warranty. It is the responsibility of the spa owner to provide a proper foundation for the spa.

Place the spa on an elevated 3 to 4" / 30 cm concrete slab. Pavers, gravel, brick, sand, timbers or dirt foundations are **not** adequate to support the spa.

We strongly recommend that a qualified, licensed contractor prepare the foundation for your spa.

If you are installing the spa indoors, pay close attention to the flooring beneath it. Choose flooring that will not be damaged or stained.

If you are installing your spa on an elevated wood deck or other structure, it is highly recommended that you consult a structural engineer or contractor to ensure the structure will support the weight of 150 pounds per square foot (732 kg / m²).

To properly identify the weight of your new spa when full, remember water weighs 8.33 lbs. per gallon, or 1 kg per

liter. For example, an average 8' spa holds approximately 500 gallons, or 1892 liters, of water. Using this formula, you will find that the weight of the water alone is 4,165 lbs, or 1892 kg. Combined with the dry weight of the spa you will note that this spa will weigh approximately 5,000 lbs, or 2267 kg, when full of water.



12" / 30 cm
minimum
distance
from
edge

240 Volt Electrical Installation

All 240V spas must be permanently connected (hard wired) to the power supply. See the GFCI and wiring requirements on page 4.

These instructions describe the only acceptable electrical wiring procedure. Spas wired in any other way will void your warranty and may result in serious injury.

When installed in the United States, the electrical wiring of this spa must meet the requirements of NEC 70 and any applicable local, state, and federal codes.

The electrical circuit must be installed by an electrical contractor and approved by a local building or electrical inspector.

Failure to comply with state and local codes may result in fire or personal injury and will be the sole responsibility of the spa owner.

The power supplied to the spa must be on a dedicated GFCI protected circuit as required by NEC 70 with no other appliances or lights sharing the power.

Use copper wire with THHN insulation. Do not use aluminum wire.

Use the table below to determine your GFCI and wiring requirements.

Wires that run over 100 feet must increase wire gauge to the next lower number. For example: A normal 50 amp GFCI with four #6 AWG copper wires that run over 100 feet would require you to go to four #4 AWG copper wires.

Wiring Requirement/GFCI Wiring Diagram

Control System	GFCI Required	Wires Required
BP501G1 (one pump system)	One 40 amp GFCI	Four #8 AWG copper wires
BP501G1 (two pump system) BP501X BP20X	One 50 amp GFCI	Four #6 AWG copper wires

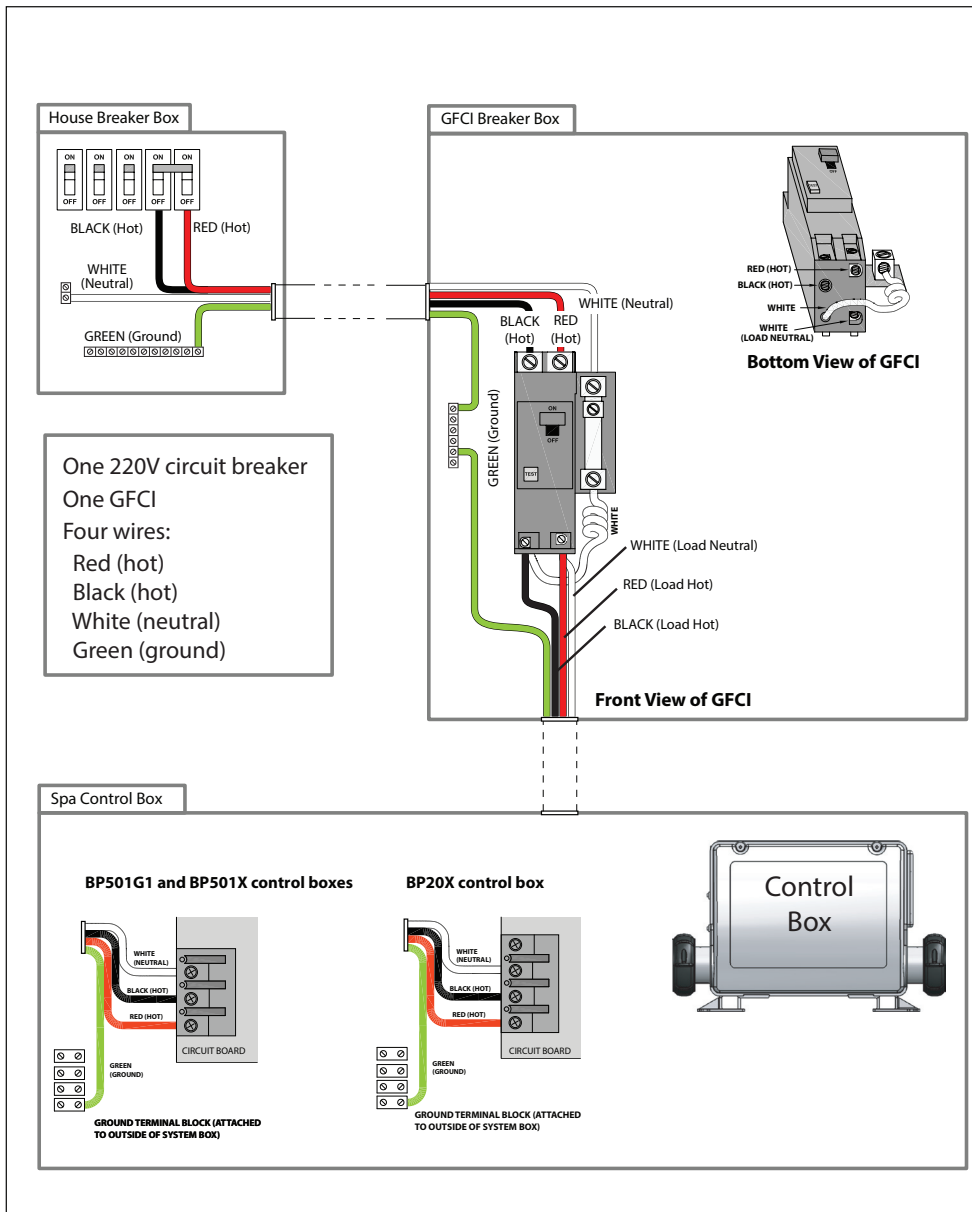

See the Cal Spas Pre-Delivery Guide for more information on spa placement for service access and electrical service.
www.calspas.com/manuals

120 Volt Electrical Installation

Always follow applicable local, state and federal codes and guidelines.

Use only a dedicated electrical line with a 15 amp breaker.

Cord-and-plug connections may not use a cord longer than 15 feet (4.6 m) and must be plugged into a dedicated 15 amp GFCI connection (NEC 680.42(A) (2)). Do not use extension cords!

Always use a weatherproof-covered receptacle.

Receptacle shall be located not less than 5 feet (1.5 m) from and not exceeding 10 feet (3.0 m) from the inside wall of the spa. (NEC 680.43(A))

Do not bury the power cord. If your cord becomes damaged, replace it before next usage.

All 120V spas must have a GFCI. This can be either a 15 amp GFCI receptacle or a 15 amp GFCI cord and plug kit as shown (CKIT110 - P/N ELE09700086).

Testing the GFCI plug

Test the GFCI plug prior to first use and periodically when the spa is powered.

1. Plug in the GFCI into the power outlet. The indicator should turn on.
2. Press the TEST button. The GFCI will trip, the indicator will turn off, and the spa will stop operating.
3. Press the RESET button. The GFCI will reset, the indicator will turn on again, and the spa will turn back on.

The spa is now safe to use.

If the GFCI trips while the spa is in use, press the RESET button. If the GFCI does not reset, unplug the spa and call your local Cal Spas dealer for service. **DO NOT USE THE SPA!**



Testing the 240 Volt GFCI Breaker

Test the GFCI breaker prior to first use and periodically when the spa is powered. To test the GFCI breaker follow these instructions (spa should be operating):

1. Press the TEST button on the GFCI. The GFCI will trip and the spa will shut off.
2. Reset the GFCI breaker by switching the breaker to the full OFF position, wait a moment, then turn the breaker back on. The spa should have power again.

Filling and Powering Up Your Portable Spa

1. Inspect the spa equipment.

Inspect all plumbing connections in the equipment area of your spa.

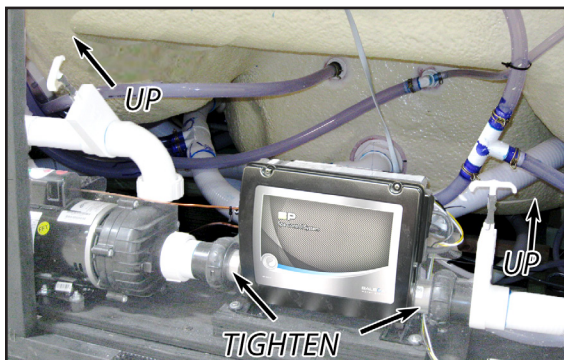

- Make sure unions in the equipment pack are tight. (Be careful not to over-tighten the plumbing fittings.)
- If your spa has gate valves, make sure they are all in the UP or OPEN position.
- Make sure the drain valve is closed and capped. (See page 37 for a description of drain valves.)

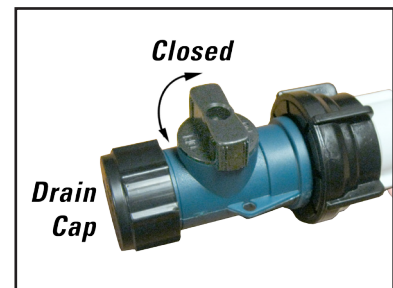

Never run the spa with the gate valves closed or without water circulating for long periods of time.

2. Remove the cartridge from filter canister.

If you have a skimmer like this:

Grip the filter by the handle and unscrew it from the canister.



If you have a skimmer like this:

Remove the black skimmer cap and barrel, grip the filter by the handle and unscrew it from the canister.



Teleweir Mega filter skimmer

- 75 square feet filtration
- Smooth cap

If you have a skimmer like this:

Rotate and remove the black locking ring. Remove the black skimmer cap and barrel, grip the filter by the handle and unscrew it from the canister. Replace and lock the locking ring and slide the skimmer cap and barrel back in the canister.

Note: The skimmer cap and barrel were locked in place at the factory to prevent damage during shipment. It must be unlocked and replaced in the filter canister so that it can float when the spa is filled. If you do not remove the cap and barrel, your spa's filtration system will not perform as it was designed to.



Teleweir filter skimmer

- 50 square feet filtration
- Spoked cap



After you remove the filter, remove the plastic wrapper and soak it in water for 30 minutes before you replace it. A dry filter can allow air into the filtration system which can cause the pump to fail to prime.

3. Fill the spa.

Place a garden hose in the filter canister and fill your spa.

Always fill the spa through the filter canister. Failure to do so may cause air to be trapped in the filtration system and prevent the pumps from operating properly.



Fill the spa until water level is about six inches from the top.

If the water level is too low or too high, your spa will not operate properly.

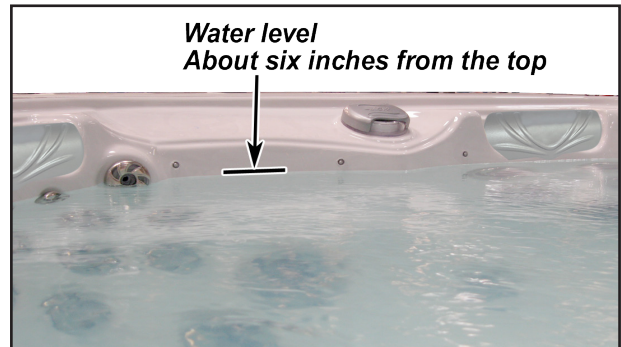

Never fill your spa with soft water.

Soft water makes it impossible to maintain the proper water chemistry and may cause the water to foam, which will ultimately harm the finish of the spa and void your warranty.

4. Turn on power to the spa.



When the spa is filled to the correct level, turn on the power at the GFCI breaker. (Ensure that the 120V spas are connected to the proper electrical outlet.)

5. Prime the pump.



Your spa will perform a self-diagnostic check and go into Priming Mode. The control panel will display either **RUN PUMPS PURG AIR ---** or **Priming Mode**, depending on which control panel you have.

Do the following:

Press the JETS or JETS 1 button once to start the pump in low speed.

- a. Press it again to switch the pump to high speed.
- b. If you have other pumps, press JETS 2 or JETS 3 to turn them on also.

Running the pumps helps the pumps prime.

After two minutes, the pump should prime. If it does not, follow the priming instructions on the next page. If it does, continue with the next step.

6. Install the filter into the filter canister.

 Make sure the filter has soaked at least 30 minutes before you install it.



7. Adjust water chemistry.

Test and adjust the water chemistry. See the section on page 25 for instructions on keeping your water clear.

Spa owners with the bromine generator need to follow the instructions on page 34.

8. Let the spa heat up.

When the spa has finished priming, the heater will activate. Put the cover on and let the spa heat to the set temperature.

Priming the Pump

New spa owners often have difficulty the first time they start their spa and the pump fails to prime. This can be frustrating, but these simple instructions can help you.

Sometimes air can become trapped in the pump while filling the spa. You will know this has happened when after you have filled and started the spa, the pump does not seem to function. You will hear the pump operating, but no water will be moving.



The pump will not work properly while air is trapped in it. Continuing to operate the pump in this way will cause damage.

Starting Up: Priming Mode

After the initial start-up sequence, the spa will enter Priming Mode, which lasts 4 to 5 minutes. The message shown right will appear.

RUN

PMP5

PURG

AIR

As soon as the Priming Mode screen appears on the panel, press the Jets or Jets 1 button once to start Pump 1 in low speed and then again to switch to high speed. Also, select the other pumps, to turn them on. The pumps should be running in high speed to facilitate priming.

If the pumps have not primed after two minutes, and water is not flowing from the jets in the spa, do not allow the pumps to continue to run. Turn off the pumps and repeat the process. Note: Turning the power off and back on again will initiate a new pump priming session.

Sometimes momentarily turning the pump off and on will help it to prime. Do not do this more than five times. If the pumps will not prime, shut off the power to the spa and call for service.

Important: A pump should not be allowed to run without priming for more than two minutes. Under NO circumstances should a pump be allowed to run without priming beyond the end of the 4 to 5 minute priming mode. Doing so may cause damage to the pump and cause the system to energize the heater and go into an overheat condition.

Exiting Priming Mode

You can manually exit Priming Mode by pressing an Up or Down button. Note that if you do not manually exit the priming mode as described above, the priming mode will be automatically terminated after 4 to 5 minutes. Be sure that the pumps have been primed by this time.

Once the system has exited Priming Mode, the top-side panel will momentarily display the set temperature but the display will not show the temperature yet. This is because the system requires approximately one minute of water flowing through the heater to determine the water temperature and display it.

Bleeding Air from the Pump

If you have tried priming the pump several times unsuccessfully using the control panel, you can bleed the air from the pump manually.

1. Shut off the power to the spa.
2. Using a Phillips screwdriver, remove the front panel from the spa and locate the pump.
3. Close the gate valve on the discharge side of the pump (if your spa is installed with one.)
4. Turn the bleeder valve counter clockwise with a small pair of pliers until the air has been released from the pump.
5. If this is unsuccessful, loosen the union nut on side of the pump with channel locks. When air is bled out, tighten the nut.
6. Turn on power to the spa and press the **JETS** button. If there is still air trapped in the pump, repeat steps 2 through 5 until the pump primes.

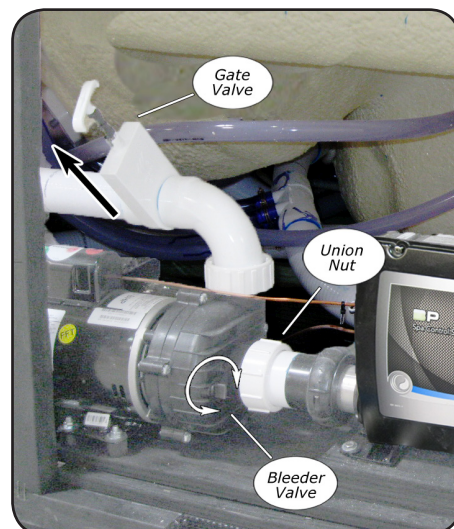

Operating Your Spa

TP400 and TP600 Control Panel Operation

Primary Navigation and Functions

Navigating and programming the entire menu structure is done with 2 or 3 buttons on the control panel. During normal operation, the control panel will show the actual temperature of the water, as the control panels below illustrate.

There are eleven settings, or menu items, you can access in the control panel. To access them in order, start by pressing the **Warm** or **Cool** button once. The Set Temperature will start to flash. While the set temperature is still flashing, press the **Light** button. This will take you to the next menu item. Each time you press the **Light** button, it will take you to the next screen.

The figures below show the order the menu items appear. Tap each menu item to go to the section that explains its function.



TP400 Control Panels

For one pump systems



For two pump systems



TP600 Control Panels

For two and three pump systems



For one pump systems

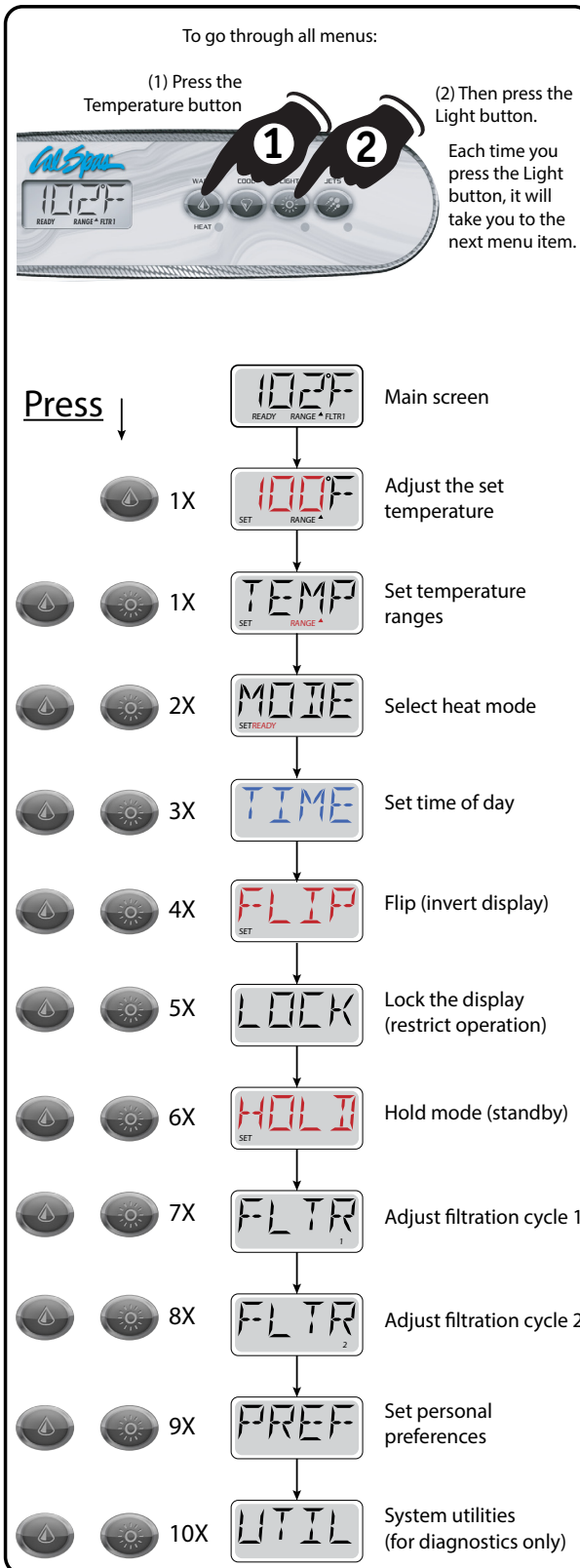
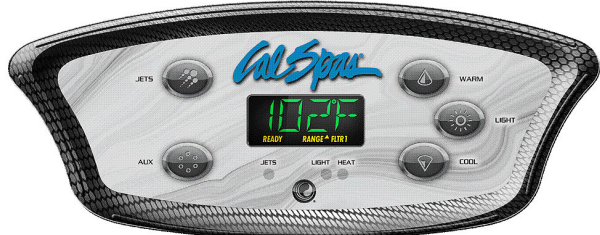

Jets and Pumps

Jet Operation

One Pump Systems

Uses the TP400 control panel

Single pump systems are all two-speed pumps.

To operate the jets, press the **JETS** button:

- Once to turn on low speed.
- Twice to turn on high speed.
- Three times to turn off the pump.



Jets

Two pump systems

Uses either the TP400 or TP600 control panel

Press the **Jets** or **Jets 1** button:

- Once to turn on low speed.
- Twice to turn on high speed.
- Three times to turn off the pump.



Jets

Press the **Aux** or **Jets 2** button:

- Once to turn the pump ON.
- Twice to turn the pump OFF.



Aux

Three pump systems

Uses the TP600 control panel

Press the **Jets 1** button:

- Once to turn on low speed.
- Twice to turn on high speed.
- Three times to turn off the pump.



Jets

Press the **Jets 2** button:

- Once to turn the pump ON.
- Twice to turn the pump OFF.



Jets

Press **Jets 3** button:

- Once to turn the pump ON
- Twice to turn pump OFF.



Aux

What is the difference between a 24-hour circulation pump and a two-speed pump?

Circulation Pump - A 24-hour circulation pump is an optional, dedicated low power pump just for filtration. A circulation pump will reduce wear and tear on main pump and can cost less to run than using pump 1 for filtration. When a spa has a circulation pump, pump 1 will have only one speed.

Although it can be set to run continuously, some spa owners prefer to reduce their filtration times in order to lower their energy cost. See "Adjusting Filtration" on page 14.

Two-Speed Pump - Spas without a circulation pump use the low speed setting of pump 1 as a circulation pump. Pump 1 will have two speeds, low speed and high speed. Low speed is used for filtration, and high speed is used for operating the jets.

Adjusting the Set Temperature

Press  Once

Press the WARM or COOL buttons to adjust the set temperature.

When the temperature stops flashing, the spa will heat to the new set temperature when required. The temperature can be set between 60°F and 104°F.

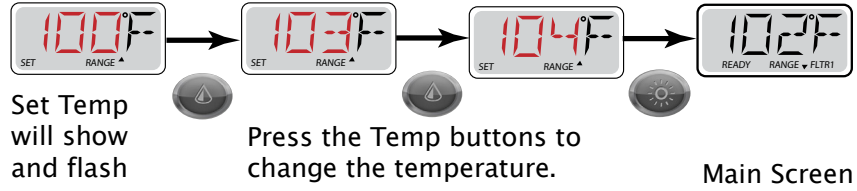



Set Temp will show and flash

Press the Temp buttons to change the temperature.

Main Screen

Setting Dual Temperature Ranges

Press  Once

Then Press  Once

You can set two temperature range settings with independent set temperatures. The High Range is shown in the display by an "up" arrow and the Low Range with a "down" arrow. The ranges can be used for different reasons, the most common being a "ready to use" setting versus a "vacation" setting. (See "Vacation Setting below.") Each range maintains its own set temperature that you program according to your needs. This way, when a range is chosen, the spa will heat to the set temperature programmed to that range.

High Range can be set between 80°F and 104°F.

Low Range can be set between 50°F and 99°F.

The example below shows setting the Low Range temperature.

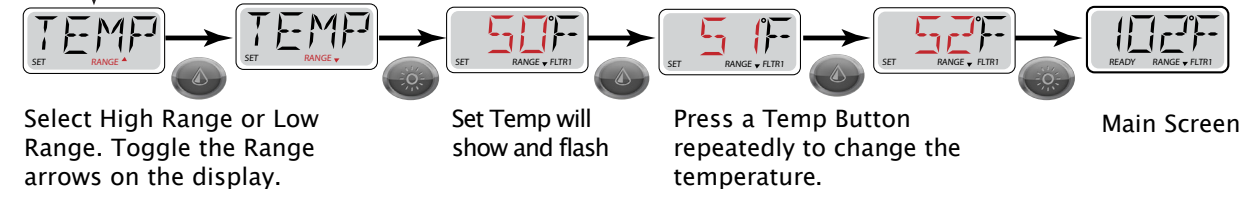

Select High Range or Low Range. Toggle the Range arrows on the display.

Set Temp will show and flash

Press a Temp Button repeatedly to change the temperature.



Main Screen

Vacation Setting

Set the spa to operate in the Lower Range temperature choice before you go on vacation.

1. Press the Temp button. The "Set Temp" will show and flash.
2. Press the Light button. "TEMP" will show on the display, which give you the choice of High Range or Low Range.
3. To set the Low Range, press the Light button, then
4. press the Temp button. The "Set Temp" will show and flash.
5. Press the Temp buttons to adjust the temperature.
6. Press the Light button or wait several seconds to return to the main screen.

Setting the Heat Mode

Press  Once
Then Press  Twice



There are two heat modes: READY Mode and REST Mode.

READY Mode: In order for the spa to heat, a pump needs to circulate water through the heater. The pump that performs this function is known as the “heater pump.”

The heater pump can be either a 2-Speed Pump 1 or a circulation pump. If the heater pump is a 2-Speed Pump 1, READY Mode will circulate water every 1/2 hour, using Pump 1 Low, in order to maintain a constant water temperature, heat as needed, and refresh the temperature display. This is known as “polling.”

REST Mode: REST Mode will only allow heating during programmed filter cycles. Since polling does not occur, the temperature display may not show a current temperature until the heater pump has been running for a minute or two.

Ready-in-Rest Mode

READY/REST appears in the display if the spa is in Rest Mode and Jet 1 is pressed. When the spa is being used, it will heat

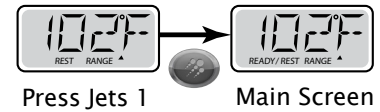



to set temperature. While Pump 1 High can be turned on and off, Pump 1 Low will run until set temperature is reached, or 1 hour has passed. After 1 hour, the system will revert to Rest Mode. This mode can also be reset by entering the Mode Menu and changing the Mode.

Freeze Protection

If you live in an area that experiences extreme freezing weather, you need to know how to set your spa to prevent freeze damage. Some spa owners choose to drain and winterize their spas, but others prefer to keep it filled and operating. If you don't want to drain your spa, you can continue to run it safely through the winter, providing you program it correctly.

When you expect the temperature to approach freezing, always keep the spa in READY Mode. As long as the spa is in READY Mode, it will regularly check the water temperature (known as “polling”) and circulate water every 1/2 hour. When the sensors within the heater detect water temperature has dropped to 42°F (5.5°C), then the pumps and the blower automatically activate to provide freeze protection. The pumps and blower will run either continuously or periodically depending on conditions.

Setting Time



Press  Once
Then Press  3X

Setting the time of day is important for determining filtration times and other background features. 24-hour time display can be set under the PREF menu.

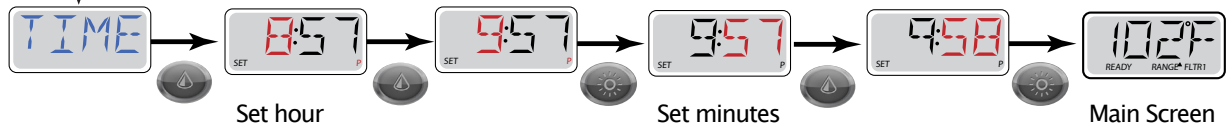
Note: This system does NOT display the time of day. The default display on the Main Screen is the current water temperature. Displaying time of day is not a selectable feature.



Flip (Invert Display)

Press  Once
Then Press  4X

Inverting the display allows you to be able to read the control panel while you are in the spa.

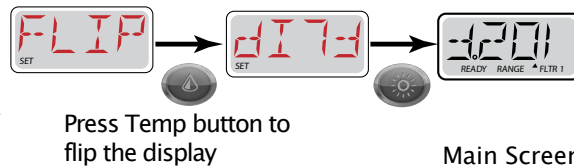

Locking the Control

Press  Once
 Then Press  5X

The control can be locked to prevent unwanted use or temperature adjustments. You can lock the set temperature or the control panel.

Locking the temperature allows Jets and other features to be used, but the Set Temperature and other programmed settings cannot be adjusted.

Locking the panel prevents the controller from being used, but all automatic functions are still active.

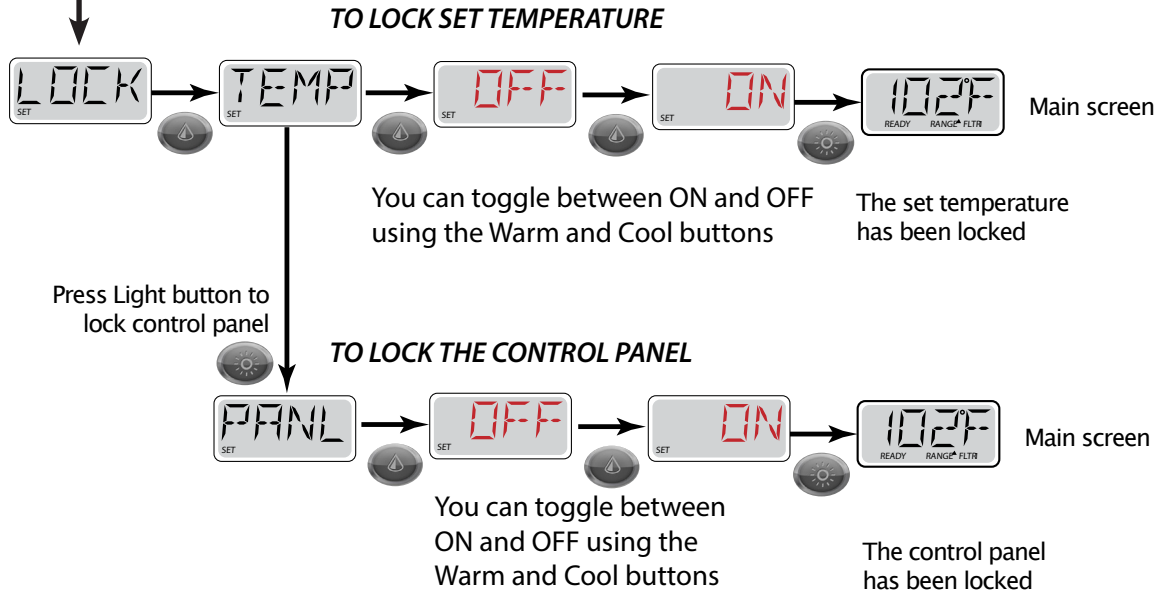

Unlocking the Control

While pressing and holding the WARM Button, press the LIGHT button twice.

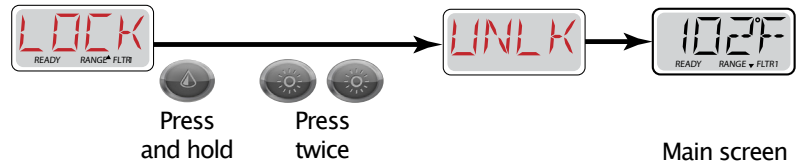

Hold Mode



Press  Once
 Then Press  6X

Hold Mode is used to disable the pumps during service functions like cleaning or replacing the filter. (See page 28 for instruction on cleaning the filter.)

Hold Mode will last for 1 hour unless the mode is exited manually.



Adjusting Filtration

Press  Once
Then Press  7X

Main Filtration

Filter cycles are set using a duration. Each setting can be adjusted in 15-minute increments. Filter Cycle 1 and Filter Cycle 2 (if enabled) are set to the same duration.

If Filter Cycle 2 is enabled, Filter 2 will appear in the LCD. If Filter 2 is disabled, Filter 1 will appear.

Note: The default setting for filtration is two hours per day with one filtration cycle. This will probably not be enough for your needs. See page 28 for information about determining how much filtration your spa needs.

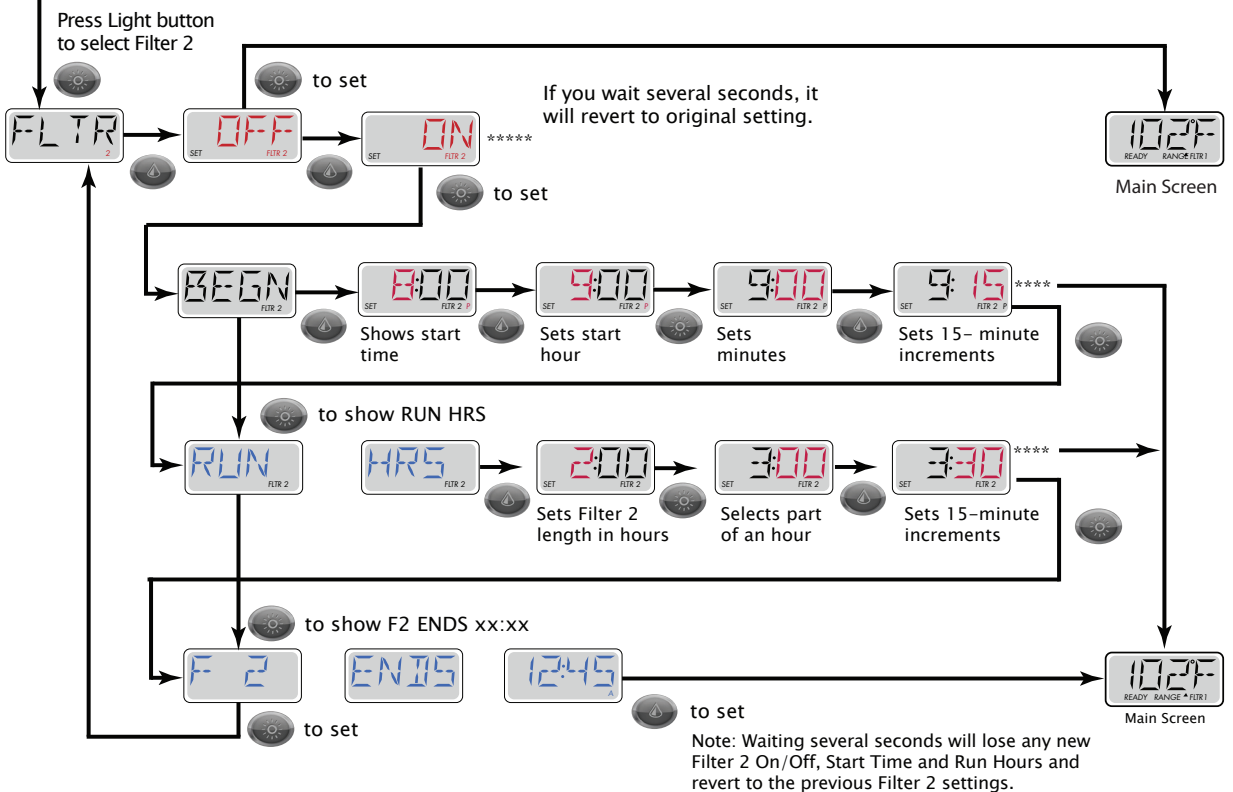
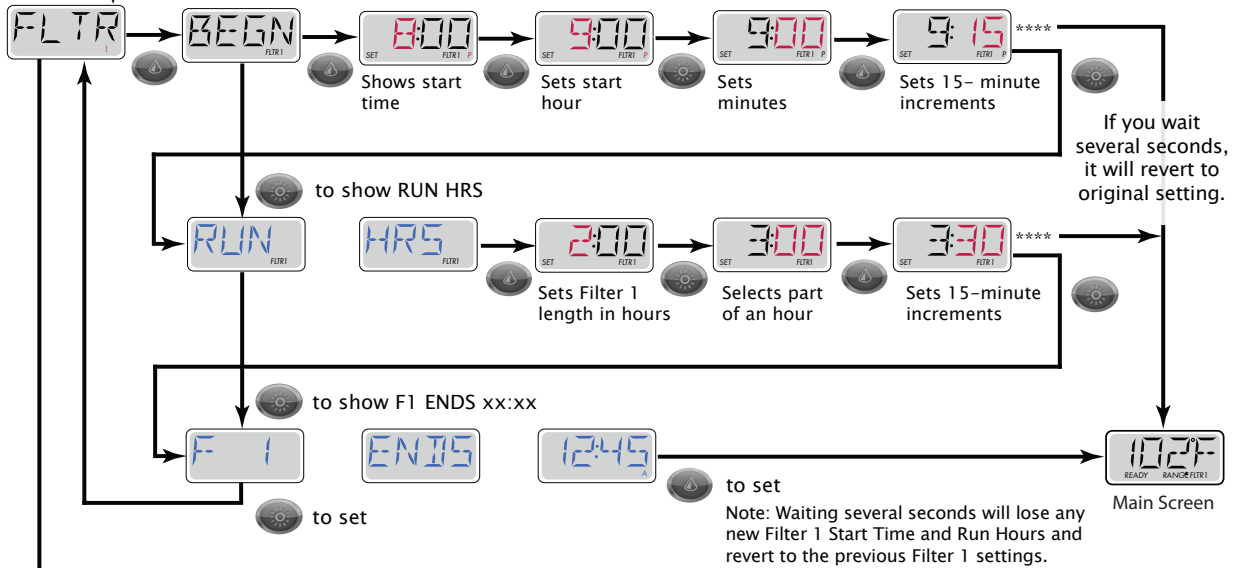

Setting Preferences

Press  Once
Then Press  9X

This allows you to set the following preferences for system operation:

- Change the temperature between Fahrenheit and Celsius
- Change the clock between 12-hour and 24-hour display
- Turn periodic reminders (like "CLEAN FILTER") on or off

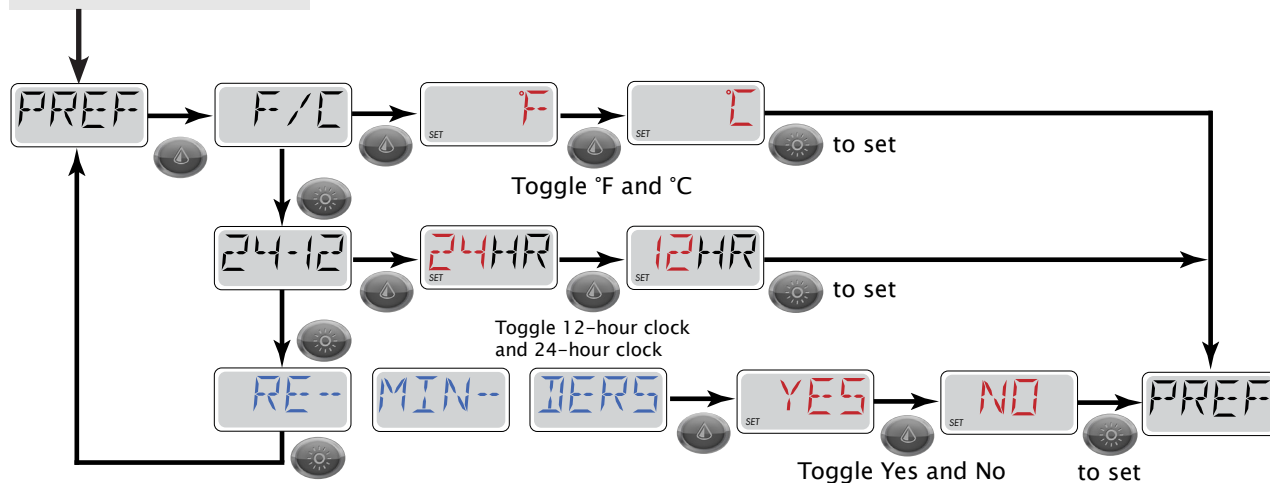

Utilities

This menu feature is for system information only and is used mainly for repair and troubleshooting.

Other Spa Systems

Several spa functions operate in the background and require no action or maintenance from you. This is for your information only.

Pumps

Press the "Jets 1" button once to turn pump 1 on or off, and to shift between low- and high-speeds if equipped. If left running, the pump will turn off after a time-out period. The pump 1 low-speed will time out after 30 minutes. The high-speed will time out after 15 minutes.

On non-circ systems, the low-speed of pump 1 runs when the blower or any other pump is on. If the spa is in Ready Mode, Pump 1 low may also activate for at least 1 minute every 30 minutes to detect the spa temperature (polling) and then to heat to the set temperature if needed. When the low-speed turns on automatically, it cannot be deactivated from the panel, however the high speed may be started.

Circulation Pump

The circulation pump will come on when the system is checking temperature (polling), during filter cycles, during freeze conditions, or when another pump is on.

The ozonator will run with the circulation pump during filtration cycles.

Purge Cycles

In order to maintain sanitary conditions, secondary Pumps and/or a Blower will purge water from their respective plumbing by running briefly at the beginning of each filter cycle.

Diagnostic Messages

Message	Meaning	Action Required
RUN PMPS PURG AIR	<p>Priming Mode</p> <p>Each time the spa is powered up, it will enter Priming Mode. The purpose of Priming Mode is to allow the user to run each pump and manually verify that the pumps are primed (air is purged) and water is flowing. This typically requires observing the output of each pump separately, and is generally not possible in normal operation.</p>	<p>Priming Mode lasts 4 minutes, but you can exit it earlier by pressing any Temp button. The heater is not allowed to run during Priming Mode.</p> <p>NOTE: If your spa has a Circ Pump, it will turn on with Jets 1 in Priming Mode. The Circ Pump will run by itself when Priming Mode is exited.</p>
---F - ---C	<p>Water Temperature Is Unknown</p> <p>After the pump has been running for 1 minute, the temperature will be displayed.</p>	None.
42F TOO COLD	<p>Too Cold - Freeze Protection</p> <p>A potential freeze condition has been detected and all pumps and blower are activated. All pumps and blower are ON for at least 4 minutes after the potential freeze condition has ended. In some cases, pumps may turn on and off and the heater may operate during Freeze Protection.</p>	None.
WATR TOO HOT	<p>Water Is Too Hot</p> <p>One of the water temp sensors has detected spa water temp 110°F (43.3°C) and spa functions are disabled.</p>	None. System will auto reset when the spa water temp is below 108°F (42.2°C). Check for extended pump operation or high ambient temp.
SFTY TRIP ----	<p>Safety Trip - Pump Suction Blockage</p> <p>The Safety Trip error message indicates that the vacuum switch has closed. This occurs when there has been a suction problem or a possible entrapment situation avoided. (Note: not all spas have this feature.)</p>	Drain or filter may be covered, creating a blockage. Clear the blockage and reset by pressing any button on the topside panel.
HTR FLOW LOSS ----	<p>Heater Flow Is Reduced</p> <p>There may not be enough water flow through the heater to carry the heat away from the heating element.</p>	Check for low water level, suction flow restrictions, closed valves, trapped air, too many closed jets and pump prime. Heater start up will begin again after about 1 minute.
HTR FLOW FAIL ----	<p>Heater Flow Is Reduced</p> <p>There is not enough water flow through the heater to carry the heat away from the heating element and the heater has been disabled.</p>	Check for low water level, suction flow restrictions, closed valves, trapped air, too many closed jets and pump prime. Heater start up will begin again after about 1 minute.
HTR MAY BE DRY ---- WAIT ----	<p>Heater May Be Dry</p> <p>Possible dry heater, or not enough water in the heater to start it. The spa is shut down for 15 min.</p>	Check for low water level, suction flow restrictions, closed valves, trapped air, too many closed jets and pump prime. Press any button to reset the heater start-up.
HTR DRY ----	<p>Heater Is Dry</p> <p>There is not enough water in the heater to start it. The spa is shut down.</p>	Check for low water level, suction flow restrictions, closed valves, trapped air, too many closed jets and pump prime. Press any button to reset the heater start-up.

Message	Meaning	Action Required
HTR TOO HOT ----	Heater Is Too Hot One of the water temp sensors has detected 118°F (47.8°C) in the heater and the spa is shut down.	Check for low water level, suction flow restrictions, closed valves, trapped air, too many closed jets and pump prime. Press any button to reset when water is below 108°F (42.2°C).
PRES BTTN TO RSET ----	Spa Needs To Be Reset This message may appear with other messages.	Press any button on the topside control to reset.
102F SNSR BAL- ANCE	Sensor Balance Is Poor The temperature sensors MAY be out of sync by 2°F or 3°F.	Call for service.
SNSR SYNC ---- CALL FOR SRVC ----	Sensor Balance Is Poor The temperature sensors ARE out of sync.	Call for service. Note: This message can be reset from the topside panel with any button press.
SNSR A ---- CALL FOR SRVC SNSR B ---- CALL FOR SRVC	Sensor Failure A temperature sensor or sensor circuit has failed.	Call for service.
NO COMM	No Communications The control panel is not receiving communication from the system.	Call for service.
102°T	°F or °C Is Replaced by °T The control system is in Test Mode.	Call for service.
STUK PUMP ----	A Pump Appears To Be Stuck ON Water may be overheated.	POWER DOWN THE SPA. DO NOT ENTER THE WATER. Call for service.
HOT FALT ---- CALL FOR SRVC ----	A Pump Appears To Be Stuck ON A pump appears to have been stuck ON when spa was last powered.	POWER DOWN THE SPA. DO NOT ENTER THE WATER. Call for service.

Cal Spas Hot Tub Wi-Fi App

The Cal Spas Hot Tub Wi-Fi app can provide you with instant access and control of your spa wherever you connect within the spa's Wi-Fi range. This optional feature is available for use with any smart device (Android™ or iOS™ systems only). You must have the Wi-Fi module installed in your spa in order to use the app. It is only available for spas with the BP501 or BP2000 control box.

Spa owners who do not have this feature installed on their spa at the factory can order it as an after-market item.

Installing the app



Go to the Apple app store or Google Play and search for the free spa app using the key words "Cal Spas Hot Tub." Select the app. The icon for the app will appear on your device as shown at left.

Make sure you enable Wi-Fi on your phone before you run the app.

On the Wi-Fi connections screen on your device, a network will appear called "BWGSpa_xxxxxx_". (The x's represent the Wi-Fi module's local address and is unique for every spa.) Once you are connected to the network, start the Cal Spas app and follow the prompts on the screen. (Your start screen maybe different.)

1. Tap the app button on the main screen of your device.
2. Connect to the spa's Wi-Fi signal.
3. When connected, you will be taken to the main app screen.
4. You are now directly connected to your hot tub and can control all the hot tub functions via the app.

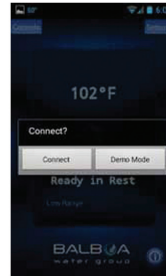
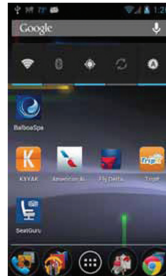

Troubleshooting connection problems

You should have few problems connecting with the Wi-Fi app. However, if you are unable to connect quickly and easily to the spa's Wi-Fi source, try doing the following.

- Enable Wi-Fi on your device. This is the most likely reason you may not be able to connect to the app. Check your devices Wi-Fi settings and try connecting again.
- Power cycle the spa. Shut off power to the spa for 30 second and turn it back on. Wait until the spa has gone through its complete set-up routine before you try to connect with the Wi-Fi app.
- Wait until the spa has completely primed. When you turn on the spa, it will go through a priming routine, which is followed by temperature polling, where no temperature is shown on the control panel. As soon as a temperature appears, you can connect with the Wi-Fi app.
- If you use your home network router, it **MUST** be close enough to the spa in order for the spa's Wi-Fi signal to reach the router. If you have connectivity problems, you may need to relocate your router closer to your spa or consider adding a wireless signal booster to your router.

Connecting to a Device or Network

1 Direct connection

Range: About 20 feet
Range limit: Limited to the range of the wi-fi module



HOW TO CONNECT TO IT:

Install the app on your phone or device -- see the following section "Installing the app".

2

Through home network with no internet access

Allows one local connection at a time

Range: About 50 feet
Range limit: Limited to the range of your home router's signal

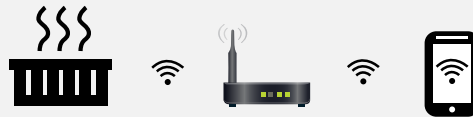

HOW TO CONNECT TO IT:

1. Install the app on your phone or device.
2. Exit the app and go to wi-fi settings on your phone or device.
3. Select and enable your local router.
4. Start the app. After you connect, select Settings on the home screen.
5. On the Settings screen, select Advanced, then on the Advanced screen, select Wi-fi Settings.
6. On the Wi-fi screen, select WPA. Then select the name of your home router from the drop-down menu.
7. Enter the SSID and Key for your router, then tap Save and select OK twice.
8. Close the app and re-start it to connect to your home network.

3

Through a network with internet access, using Cloud connection or other hotspot connection

Allows unlimited simultaneous connections

Range: Worldwide
Range limit: Limited to 3G / 4G / hotspot availability

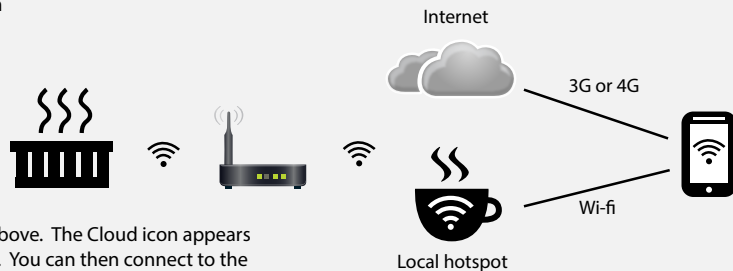

HOW TO CONNECT TO IT:

Follow connection instructions from section (2) above. The Cloud icon appears automatically when network connection is made. You can then connect to the spa's wi-fi module.

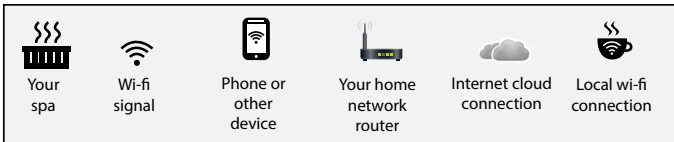

Cloud Service

Cal Spas Wi-Fi can be used as a point to point remote control to be added to any home network free of charge. Those using the Cloud to access spa control from nearly anywhere in the world via the Internet will enjoy one year Cloud service free of any access charge. After the initial year of Cloud service, the user will receive a notice from the Cloud provider requiring a small charge for each continuing year of Cloud service. At the time of this publication, the annual fee for this service is \$24. Once your device is paired and connected, all sounds from your device will be played through the spa's optional sound system, including system sounds and telephone messages. The Wi-Fi package contents are pictured below.



Cal Spas app



Cal Spas WiFi Module
Part # ELE 50350-04



1 Year of Cloud
Remote Access*

* You will receive a notification approximately 45 days prior to the end of the expiration of your Cloud access with instructions on how to renew.

For More Information

If you have any trouble connecting, you can find more in-depth instructions at the Balboa Water Group web site at www.balboawatergroup.com/bwa and download the PDF document "Setting Up Your Wi-Fi".

There are also installation and setup videos at www.youtube.com/user/balboawatergroup.

Jets

Almost all of the jets in your spa are adjustable. Rotating the face of an adjustable jet to the left (counterclockwise) will decrease the amount of water flow through the jet. Rotating the face of an adjustable jet to the right (clockwise) will increase the amount of water flow through the jet. (See example shown here.)

Neck jets adjust in the opposite directions (counterclockwise to increase, clockwise to decrease).



Microsilks Therapy System



Aux

The optional Microsilks feature is available with Connect and Escape spas only.

The Microsilks system generates microbubbles that are 50 to 100 times smaller than ordinary air bubbles. The microbubbles are oxygen-rich and help hydrate your skin.

Press the **Aux** button to start the Microsilks pump. When the spa water becomes saturated with the microbubbles, it will turn white to create an ideal Microsilks environment.

The Microsilks pump will run for 15 minutes or until you press **Aux** to turn it off. When the pump cycle finishes, you can press **Aux** to start the Microsilks pump again.

Aquatic Air Therapy™ (AAT)

AQUATIC AIR THERAPY™ JETS

The Aquatic Air Therapy™ (AAT) Jets in conjunction with the massage ring provides a massage therapy experience for sore muscles or aching joints (Available only in select areas of spa).



FLEX JET™

The Flex Jet™ delivers a gentle but strong stream of water to more delicate areas of the body including wrists, joints and extra sensitive muscles. Experience immediate alleviation from the massage ring included on the Flex Jet™.



DUO JET™

The Duo Jet™ is perfect for larger parts of your body including lower back, legs and shoulders. Place your back on the the Duo Jet™ for a complete rehabilitating massage therapy experience.



PRECISION JET™

The Precision Jet™ emits the perfect combination of air and water to target specific problematic areas while a soft massage ring provides relief on contact. Relieve muscle tension and soreness with the Precision Jet™.



AAT AIR CONTROL

The Aquatic Air Therapy™ has its own dedicated Air Control that allows you to adjust the air flow precisely to create your total spa therapy experience.



Ultimate Feet Therapy

LED Perimeter Lighting

Press the LIGHT button on the topside control panel to turn the spa light on. If your spa has perimeter LED lights, they will also light up at the same time as the spa light.

The perimeter lights operate in three modes:

- 1. **Cycle:** The first time you press the LIGHT button, the lights will cycle through all the colors in this order:

- White
- Cyan
- Magenta
- Blue
- Yellow/green
- Green
- Red

To cycle through the different color choices, press the button repeatedly. Each time you press the button, you advance to the next color.

- 2. **Flashing white:** When you have cycled through all the colors, the next time you push the LIGHT button, the LED lights will flash white.
- 3. **Fading cycle:** The next time you push the LIGHT button, the lights will gradually fade from one color to the next in the order shown above.

Spas with exterior corner LED lighting work in the same modes as described above but do not light up when the interior perimeter lights are yellow/green, green or red.

Diverter Knobs

Diverter knobs are 1" and 2" knobs located around the top of your spa. They allow you to divert water through jets from one side of the spa to the other, or in most cases from floor jets to wall jets. This is accomplished by rotating the diverter knob to the left (counterclockwise), decreasing the amount of water flow through a section of jets. To increase the amount of water flow through the other section of jets, rotate the handle to the right (clockwise).



Air Venturis

Air venturis are the 1" knobs located around the top of your spa. Each one will let you add a mixture of air with the jet pressure. This is accomplished by rotating the air venturi knob to the left (counterclockwise) to increase the amount of airflow through the jets. To decrease the amount of airflow through the jets, rotate the handle to the right (clockwise).



Waterfalls

Some spa series include optional waterfalls. When the booster pump is on, rotate the dial on top (for the cascade waterfall) or turn the knob (for the hydro streamer -- see below).



Hydro Streamer Waterfall

Your spa may include two to eight streamer waterfalls. When the booster pump is on, turn the 1" diverter knob to adjust the rate of flow to the waterfall jets.

The waterfall jet faces are not adjustable. Do not turn the jet faces because you may accidentally remove them.

Always shut off water to the hydro streamer jets before you place the cover on the spa. Water from the hydro streamer jets sprays in an arc that is higher than the top surface of the spa. When water from the hydro streamer sprays the bottom of the cover, it will collect and run to the edge of the spa and drip over the top.

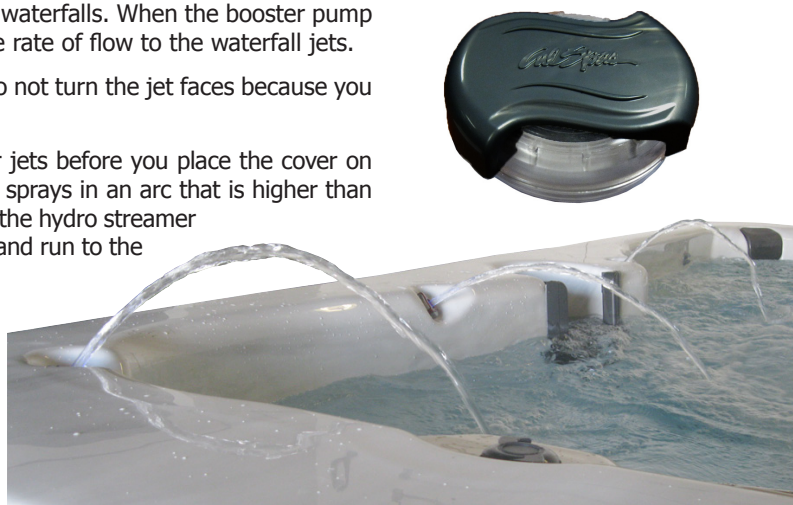

Water Clarity

This section is intended for new spa owners with no experience with water chemistry. Everyone's experience with maintaining water quality is different, but there are some general concepts you need to know.

Water maintenance is not difficult, although it requires regular attention. The most important thing to understand about taking care of your spa water is that preventive action is much easier than correcting water quality issues.

Before you begin, we recommend you become familiar with some water quality terms and their definitions (see next page).

Whether you're filling your spa for the first time (see page 5) or refilling it after draining it for regular maintenance (see page 37), start and maintain your spa water by following the plan we describe in this section.

1 Chemical Balance

See page 25 to learn how to balance your spa water.



You will need to test and adjust the chemical balance of your spa water. Although this is not difficult, it needs to be done regularly.

You need to test the level of calcium hardness, total alkalinity, and pH.

Spa owners with a bromine generator also need to check total dissolved solids and phosphates.

2 Sanitation and Shock

See page 27 to learn how to use sanitizer and shock.



Sanitizers kill bacteria and viruses and keep the water clean. A low sanitizer level will allow microbes to grow quickly in the spa water. We recommend using either chlorine or bromine as your sanitizer.

You also need to add shock to the water to stimulate the chemical sanitizer. How much you use and how often depend on frequency and intensity of use.

Spa owners with an ozonator also need to add sanitizer, although their requirements are different.

3 Filtration

See page 28 for filter cleaning instructions.



Cleaning your filter regularly is the easiest and most effective single thing you can do to keep your water clear.

A clogged or dirty filter will cause the heater and pump to work harder than they need to, possibly causing them to fail.

The spa's heating system will only function with the proper amount of water flow through the system.

4 Regularity

See page 29 for the schedule of recommended maintenance.



Clear water requires regular maintenance. Establish a routine based on a regular schedule for your spa water maintenance.

Maintaining your water quality helps the enjoyment of your spa and extends your spa's life by preventing damage from neglect and chemical abuse.

Water Quality Terms and Definitions

The following chemical terms are used in this section. Understanding their meaning will help you to better understand clear water maintenance. Words in bold type are defined in this table.

Bromine / Bromamines

Bromine is an efficient sanitizer chemical for spas. When used as a **sanitizer**, bromine forms compounds called bromamines. Bromine can be added to the spa or automatically generated. See page 27 for discussion on **sanitizers**.

Bromamines are compounds formed when bromine combines with nitrogen from body oils, perspiration, etc. Unlike chloramines, bromamines have no pungent odor and are effective **sanitizers**.

Chlorine / Chloramines

Chlorine is an efficient sanitizing chemical for spas. We recommend using sodium dichlor-type granulated chlorine because it is totally soluble and nearly **pH** neutral. When used as a **sanitizer**, chlorine forms compounds called chloramines. See page 27 for discussion on **sanitizers**.

Chloramines are compounds formed when chlorine combines with nitrogen from body oils, perspiration, etc. Chloramines can cause eye irritation as well as having a strong odor. Unlike **bromamines**, chloramines are weaker, slower **sanitizers**. To remove chloramines, see the description of **shock** below.

Calcium Hardness	Abbreviated as CH. Calcium hardness is a measure of the total amount of dissolved calcium in the water. Calcium helps control the corrosive nature of the spa's water and is why soft water is not recommended. The low CH level can cause corrosion to the equipment and can cause staining of the spa shell. See page 25 for testing for and balancing calcium hardness.
Corrosion	The gradual wearing away of metal spa parts, usually caused by chemical action. Generally, corrosion is caused by low pH or by water with levels of TA, CH, pH or sanitizer which are outside the recommended ranges.
Dichlor	Also called sodium dichlor. It is a type of chlorine and is frequently used when shocking the water . An effective chlorine -based powdered oxidizer and sanitizer . Dichlor works by oxidizing waste product in the water such as bromamines and chloramines and causing them to burn off.
Monopersulphate or MPS	Frequently used when shocking the water . An effective non-chlorine-based powdered oxidizer that works well with both chlorine and bromine . It works by oxidizing waste product in the water such as bromamines and chloramines and causing them to burn off.
Oxidizer	Shocking the water with an oxidizing chemical prevents the buildup of contaminants, maximizes sanitizer efficiency, minimizes combined chlorine and improves water clarity.
Ozone	Ozone is a powerful oxidizing agent which is produced in nature and artificially. Ozone forms no by-products of chloramines (ozone actually oxidizes chloramines) and will not alter the water's pH .
pH	The pH level is the measure of the balance between acidity and alkalinity. Low pH causes the water to be too acid, which will cause corrosion , whereas high pH causes the water to be too alkaline, which will cause scaling . See page 26 for testing for and balancing pH.
ppm	The abbreviation of "parts per million", the standard measurement of chemical concentration in water. Identical to mg/l (milligrams per liter).
Sanitizer	Sanitizer is a chemical added to the water to kill bacteria and viruses and keep the water clean. The two sanitizers we recommend are chlorine and bromine . See page 27 for discussion of sanitation.
Scale	Rough calcium-bearing deposits that can coat spa surfaces, heaters, plumbing lines and clog filters. Generally, scaling is caused by mineral content combined with high pH . Additionally, scale forms more readily at higher water temperatures.
Shock	Also called shocking the water, shock treatment, or superchlorination. Shocking the water is adding significant doses of dichlor or MPS to oxidize non-filterable organic waste and to remove chloramines and bromamines . Shock treatment breaks down organic waste contaminants which cause odor and cloudy water. See page 28 for discussion of shocking the water.
Total Alkalinity	Abbreviated as TA. Total alkalinity is the measure of the total levels of carbonates, bicarbonates, hydroxides, and other alkaline substances in the water. TA is important for pH control. If the TA is too low, the pH will fluctuate out of control, and if it is too high, the pH becomes difficult to stabilize. See page 24 for testing for and balancing total alkalinity.
Trichlor	Used as a pool sanitizer . NEVER use trichlor in a spa. Trichlor is extremely acidic and will lower the pH , causing corrosion to equipment. Using trichlor will void your warranty.

Water Testing Methods

There are two testing methods to choose from:

Test strips are a convenient testing method commonly used by spa owners.



The reagent test kit is a method which provides a high level of accuracy but is more expensive and more difficult to use.

Adding Chemicals To The Spa Water

IMPORTANT: All spa water chemicals, including MPS (shock), chlorine, granulated pH increaser or decreaser, granulated total alkalinity increaser, calcium hardness increaser, liquid stain and scale inhibitor, and liquid de-foamer must always be added directly into or in front of the filter compartment while a jet pump is running, and it must run for a minimum of ten minutes.

1. Fold back the cover.
2. Press the **Jets** or **Jets 1** button.
3. Carefully measure the recommended amount of chemical and slowly pour it into the filter area. Use care not to splash chemicals on your hands, in your eyes, on the spa surface, or on the siding.
4. Close the spa cover.

Warning: High sanitizer levels can cause discomfort to the user's eyes, lungs and skin. Always allow the sanitizer level to fall to the recommended range before using the spa.

IMPORTANT NOTE REGARDING SHOCK TREATMENT: After administering shock to your spa, leave the cover open for a minimum of 20 minutes to allow the oxidizer gas to vent. A high concentration of trapped oxidizer gas which may exist as a result of the shock treatment (not daily sanitation) may eventually cause discoloration or vinyl degradation to the bottom of the cover. This type of damage is considered chemical abuse and is not covered under the terms of the limited warranty.

1. Balancing the Water Chemistry Levels

Maintaining spa water chemistry can be tricky, especially since there are many methods of keeping your water clear and clean. Follow the maintenance schedule on page 29 to determine how often you should test your water.

We do not recommend any brand of chemical. See page 29 for a table of common chemicals used in spas and their generic equivalents.

See a spa dealer for guidance and recommendations on spa chemicals and supplies. Various chemicals often sold under brand names, but a spa dealer can advise you on generic chemicals that are often much less costly than proprietary brands.

Balancing the Total Alkalinity (TA)

Total Alkalinity is a measure of the total levels of carbonates, bicarbonates, hydroxides, and other alkaline substances in the water. TA is referred to as the water's "pH buffer". In other words, it's a measure of the ability of the water to resist changes in pH level.

If the TA is too low, the pH level will fluctuate widely from high to low. Fluctuations in pH can cause corrosion or scaling of the spa components. Low TA can be corrected by adding sodium carbonate (pH/Alkalinity Up).

If the Total Alkalinity is too high, the pH level will tend to be high and may be difficult to bring down. It can be lowered by using sodium bisulfate (pH/Alkalinity Down).

Once the TA is balanced, it normally remains stable, although the addition of more water with a high or low alkalinity will raise or lower the TA reading of the water.

When the Total Alkalinity is within the recommended range, proceed to the next step.

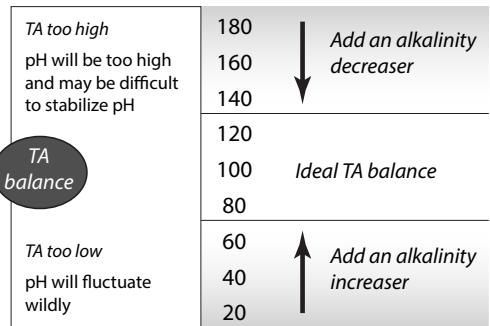

Balancing the Calcium Hardness (CH)

Calcium Hardness is a measure of the total amount of dissolved calcium in the water. Calcium helps control the corrosive nature of the spa's water. That's why calcium-low water (commonly known as "soft" water) is not recommended. It is very corrosive to the equipment, and can cause staining of the spa shell.

If the CH is too high (commonly known as "hard water"), formation of scale on the spa's shell surface and equipment can result. You can use a generic calcium remover to remove hardness from water. CH can also be decreased by dilution – a mixture of 75% hard and 25% soft water will usually yield a reading within the correct range. If soft water is not available or practical for you, a stain and scale inhibitor should be added to the spa water, according to label instructions.

If the CH is too low add CH Increaser.

Once the CH is balanced, it normally remains stable, although the addition of more water with a high or low calcium content will raise or lower the CH reading of the water.

When the CH is within the recommended range, proceed to the next step.

CH balance	<i>CH too high</i> Causes scale to deposit on spa and equipment	275 250 225	↓ <i>Dilute the spa with soft water</i>
	200 175 150		<i>Ideal CH balance</i>
	<i>CH too low</i> Causes equipment corrosion	125 100 75	↑ <i>Add a calcium hardness increaser</i>

Balancing the pH

The pH level is the measure of acidity and alkalinity. Values above 7.8 are alkaline; those below 7.2 are acidic. Maintaining the proper pH level is extremely important for optimizing the effectiveness of the sanitizer, maintaining water that is comfortable for the user, and preventing equipment deterioration.

If the spa water's pH level is too low, the following may result:

- The sanitizer will dissipate rapidly.
- The water may become irritating to spa users.
- The spa's equipment may corrode.

If the pH is too low, it can be increased by adding sodium hydrogen carbonate (pH/Alkalinity Up) to the spa water.

If the pH level is too high, the following may result:

- The sanitizer is less effective.
- Scale will form on the spa shell surface and the equipment.
- The water may become cloudy.
- The filter cartridge pores may become obstructed.

If the pH is too high, it can be decreased by adding sodium bisulfate (pH/Alkalinity Down) to the spa water.

NOTE: After adding sodium hydrogen carbonate or sodium bisulfate, wait two hours before testing the water for pH. Measurements taken too soon may not be accurate.

It is important to check the pH on a regular (weekly) basis. The pH will be affected by the bather load, the addition of new water, the addition of various chemicals, and the type of sanitizer used.

When the pH is within the recommended range, proceed to sanitation.

pH balance	<i>pH too high</i> Too alkaline, causes scaling	8.2 8.0 7.8	↓ <i>Add a pH decreaser</i>
	7.6 7.4 7.2		<i>Ideal pH balance</i>
	<i>pH too low</i> Too acidic, causes corrosion	7.0 6.8 6.6	↑ <i>Add a pH increaser</i>

2. Sanitation and Shock

Sanitizers kill bacteria and other organic waste by breaking them down to non-harmful levels which are filtered out. Before you fill your spa, you need to decide which chemical sanitizer you wish to use. Consult your Cal Spas dealer for the right decision with regards to your lifestyle and spa usage.

We recommend either **bromine** or **chlorine** as your sanitizer. Both work well when maintained regularly.



DO NOT use Trichlor. Trichlor is very acidic and the hot temperature of the spa causes it to dissolve too quickly. It will cause damage to your spa and will void your warranty.

Whichever plan you decide on, follow it completely and don't take shortcuts. It will provide you with clean, safe, clear spa water with a minimum of effort. Spa owners with an ozonator still need to use a chemical sanitizer. See page 32 for

a description of how the ozonator works.

Whenever you test your chemical levels, your test strip will likely have a test for chlorine or bromine. Make sure your sanitizer falls within the range shown below.

Testing For:	Ideal Range (ppm)	
	Minimum	Maximum
Chlorine Level		
Without ozonator	3.0	5.0
With ozonator	2.0	4.0
Bromine Level		
Without ozonator	6.7	11.0
With ozonator	5.7	10.0

Starting and Maintaining Sanitizer Levels

Sanitizing your spa with chlorine or bromine is very similar. Each sanitizer has its advantages and disadvantages.

Bromine: Whereas chlorine can sometimes cause offensive odors and skin irritation, bromine is less likely to do so. Additionally, unlike chlorine, when bromine combines with bather waste and other contaminants in the water, it remains a very effective sanitizer. Bromine is also far less pH-dependent than chlorine. **Always remember that bromine by itself is not a sanitizer, and it needs to be activated by shock in order to be effective.**

Chlorine: The most commonly recognized sanitizer is chlorine. However, the effectiveness of chlorine depends heavily on the pH level of the spa water. In order to get the most effective and economical benefit of chlorine, you must maintain a consistent pH level of between 7.2 to 7.6. A disadvantage of using chlorine is that when chlorine combines with bather waste and other contaminants in the water, not only does it lose its sanitizing ability, it can cause odors and irritate eyes and skin.

After you choose a sanitizer, you will need to establish a baseline and maintain it regularly.

Starting with fresh water:

1. Establish a baseline by adding either granulated chlorine or bromine.
 - Use half an ounce of chlorine for every 500 gallons of water.
 - Use half an ounce of bromine for every 100 gallons of water.
2. Run the jets for 10 minutes.
3. Test the water. Make sure the pH, TA, and CH levels all fall within the ranges shown on the previous page. Make adjustments where they are needed.
4. At this point, if you use bromine, it is not yet activated and **it will not sanitize the water**. You need to shock-oxidize the spa water. Depending on the size of your spa, add one to two ounces of shock. You can use any kind of shock you want.
5. Test the water again. When the water is balanced, your spa is ready to use.

Note: If you choose to use bromine, we do not recommend using a floater. You have more control over the bromine level by adding bromine as needed. For more discussion on this, see page 30, "Common Water Chemistry Questions".

Shocking the Water

In addition to using a chemical sanitizer, you will periodically need to shock the water. Shocking helps refresh the water by breaking down organic waste contaminants which cause odor and cloudy water. After treatment, water quality and clarity is often completely restored.

The two types of shock are sodium dichlor and potassium monopersulfate (MPS). You can use either type of shock regardless of which sanitizer you use. Even if you use bromine, you can use a chlorinated shock if you wish -- in fact, you may find a chlorinated shock is more effective than dichlor or MPS alone.

If irritating chloramines are present, shocking also converts them back to active chlorine. If you use bromine sanitizer, shocking activates the bromide ion (which by itself has no disinfecting capability) which becomes hypobromous acid in water, a good sanitizer.

Add one ounce of oxidizer shock once a week, after heavy bather loads, or if water has a strong odor.

Spa must be running with all of the jets on high for 30 minutes with the cover open. If necessary, repeat shock in 30 minute intervals.

3. Filtration

The filter is the part of your spa that removes the debris from the water and needs to be cleaned on a regular basis to maximize your spa's filtering performance and heating efficiency.

It is extremely important that you never run the spa without a filter. There is a possibility that debris may be sucked into the plumbing through the filter well.

Changing the Default Filtration Setting

See page 14 for instructions on using the control panel to change filtration settings.

When your spa is first powered up, the filtration setting defaults to the factory setting, which is one two-hour filtration cycle per day. This is adequate for light to moderate usage (see the topic "Bather Load" on page 32), but if you use your spa frequently or have a large number of people using it, you will need to increase the filtration.

You have two filtration cycles available, although the second one is off by default. You can turn the second cycle on if you want additional filtration time, or if you want to divide the filtration times. You can also set filter cycles 1 and 2 for different durations if you wish. Some spa owners set a long second filtration cycle to run at night when electrical power rates are lower.

If you set the spa in READY Mode (see page 12), the circulation pump will run as the spa maintains the set temperature. However, if you set it to REST Mode, the spa will heat only during filtration cycles. If this is the case, if you use the spa in the last afternoon, you may want to set the first filter cycle to run a few hours before you use it so the water will be warm.

We recommend you trying different times and durations for the filter cycles until you find a filtration plan that works for you.

Cleaning the Filter

In addition to spraying off the filter weekly to remove surface debris, your filter should be deep cleaned periodically to dissolve scale and particles that get lodged deep within the filter fibers and impede the filtration process. Even if the filter looks clean, scale and particles can clog the fibers and prevent water from flowing through the filter resulting in the most common spa problem—no heat, caused by a dirty filter.

We recommend you clean your filter at least once a month, possibly every two weeks depending on how frequently you use your spa, and replace it once a year or as necessary. See page 38 for instructions on removing and cleaning the filter.

4. Regularity (Maintenance Schedule)

Prior to each use	Test the spa water. Adjust chemical levels as necessary. Shock the water by adding ½ teaspoon of sodium dichlor per 250 gallons or 1 teaspoon of MPS per 250 gallons.
After each use	Add an ounce of oxidizer after heavy bather loads (see page 28 on shocking the water).
Once a week	Check the filter well and inside the filter pipe for leaves and foreign matter. Test the spa water. Adjust chemical levels as necessary. Shock the water by adding ½ teaspoon of sodium per 250 gallons or 3 teaspoons of MPS per 250 gallons. If your water source is high in calcium, add stain and scale preventer.
Every two to four weeks	Deep clean your spa’s filter (see page 38). How often you clean your filter depends on how much you use your spa. There is no harm in frequently cleaning your filter and will only help your spa’s efficiency.
Every two to four months	Change the spa water. How often you change the water depends on how much you use the spa. When you change the water, you will need to: <ul style="list-style-type: none"> • Clean and polish the acrylic surface (see page 39) • Clean and treat the spa cover and pillows (see page 39) • Deep clean the filter (see page 28) • Refill your spa (see page 5)
Each time you refill the spa	Follow the section “Filling and Powering Up Your Portable Spa” on page 5.
Once a year	Replace filter cartridges if the pleats appear frayed (see page 38). If you use the Cal Pure UV water sanitizer, you will need to replace the UV lamp (see page 40 for UV lamp maintenance)

Generic Names for Chemicals

Water Chemistry		
Common name	Usual chemical name	Common brand names
pH Up	sodium hydroxide	pH Increaser, pH Up, pH Plus, pH Booster
pH Down	sodium bisulfate sodium bicarbonate (baking soda) sodium carbonate	pH Decreaser, pH Down, pH Minus, pH Subtractor, Dry Acid
Alkalinity increaser	sodium carbonate sodium bicarbonate (baking soda)	Alkalinity Increaser, Alkaline Up
Alkalinity decreaser	sodium bisulfate	Alkalinity Decreaser, Alkaline Down
Calcium increaser	calcium chloride	Calcium Increaser, Calcium Up, Calcium Plus, Hardness Increaser
Calcium decreaser	N/A To decrease calcium hardness, drain several gallons of water from the spa and refill using a mixture of 75% hard water and 25% soft water, or use a stain and scale inhibitor.	

Sanitizers		
Common name	Usual chemical name	Common brand names
Chlorine	sodium dichlor	Both chlorine and bromine are available under numerous brand names
Bromine	sodium bromide	

Shock		
Common name	Usual chemical name	Common brand names
MPS	monopersulphate	MPS Shock, Oxy-Spa, SeaKlear
Dichlor	sodium dichlor	Dichlor Shock

Note: Dichlor (chlorine) is both a sanitizer and a shock. Monopersulphate (MPS), when used as a shock, can be purchased alone as non-chlorinated shock or combined with dichlor, which makes it significantly more effective than MPS alone.

Other chemical additives		
Common name	Usual chemical name	Common brand names
Stain and scale inhibitor	These are usually proprietary chemical formulations and cannot be purchased as a single generic chemical.	Metal Stain Gone, Scale Inhibitor, Stain and Scale Preventer, Stain and Scale Defense
Foam inhibitor		Foam Gone, Foam Down, Defoamer
Clarifier		Water Brite, Spa Bright, Water Clarifier, Clear Water, Natural Clarifier, Brite & Clear

Do NOT use these in your spa:

- Sodium hypochlorite (household bleach)
- Trichlor
- Chemical floaters
- Bromine tablets
- Muriatic acid
- Borax or boric acid in any form, including brand names such as 20 Mule Team Borax or generic as sodium tetraborate
- Cyanuric acid, also called sun protector or chlorine protector

Common Water Chemistry Questions

Question: Why is the use a floater not recommended to sanitize my spa water?

Answer: We do not recommend the use of a floater for three reasons:

- The floater is unable to control the rate at which the sanitizer is dissolved into the water. When a floater is first placed in a spa, the sanitizer level can be extremely high. High sanitizer levels can chemically burn or discolor the spa's shell or the underside of the cover. Then, after a period of time, the sanitizer level dispensed by the floater will fall to near zero. A low sanitizer level will allow viruses, bacteria or algae to grow.
- Floaters tend to stay in one area of the spa most of the time, causing this area to be exposed to extreme sanitizer levels.
- The floater may allow pieces of the highly concentrated sanitizer to fall out and settle on the floor or seat of the spa shell. These pieces of sanitizer will chemically burn (blister) the spa shell. Although your spa shell is specifically designed to resist the effects of spa chemicals, no spa surface can withstand this type of highly concentrated chemical. Remember, chemical abuse is specifically not covered under the terms of the warranty.

Question: When I open my spa, I smell chlorine. How do I get rid of this smell?

Answer: There are two types of chlorine in your spa. The first is the Free Available Chlorine, which is the chlorine available to sanitize your spa. This free Available Chlorine does not have an odor. The second is Chloramine, which is residue from chlorine already expended. Chloramines have a strong chlorine odor. The smell from Chloramines can be eliminated by shocking the water. If you smell chlorine in the water, your spa is reminding you to add a shock treatment.

Question: Why can't I fill my spa with soft water?

Answer: Soft water is essentially the same as regular water, except that most or all of the calcium has been replaced by sodium. Soft water may be corrosive to the heater and other components. Replacement of spa components damaged by soft water is extremely expensive.

Question: I am trying to reduce the number of chemicals to which my family is exposed. Do I really need to use so many chemicals and in such large amounts?

Answer: While over-exposure to any chemical can be unhealthy, many low levels of chemicals are effective and beneficial. In the case of spa water, the chemicals we recommend are needed to protect the user from water-borne pathogens (disease-causing microbes) and to prevent corrosion of spa components.

Question: Why isn't water chemistry damage covered by the warranty?

Answer: The chemical levels and water quality of the water in the spa are under your direct control. With proper basic care, the spa will provide many years of hot water relaxation. If you are unsure about any chemical or its usage in the spa, contact your spa dealer.

Do's and Don'ts

- DO add all chemicals slowly into or in front of the filter compartment with the jet pump operating for ten minutes.
- DO use special care if using baking soda to clean either the interior or exterior plastic surfaces.
- DO use only a granular form of bromine sanitizer.
- DON'T use swimming pool (muriatic) acid to lower pH.
- DON'T splash pH increaser additives on the siding.
- DON'T use compressed sanitizers.

The use of bromine sticks or tablets in floaters, which may become trapped in a lounge or cooling seat (or sink to the spa floor), have been shown to cause discoloration of or surface distress to a spa's shell.

- DON'T use a floater type sanitization system as a low or no maintenance solution to your spa maintenance program.

Floating dispensers can become trapped in one area and cause an over-sanitization (or chemical burn) of that particular area.

If the dispenser setting is too high, the high concentration can discolor the spa shell and damage the underside of the cover.

Automatic floating dispensers have a tendency to either over-brominate or under-brominate as the rate of erosion varies greatly. Damage to the spa and cover can occur very quickly.

- DON'T use a sanitizer which is not designed for spas.
- DON'T use household bleach (liquid sodium hypochlorite).
- DON'T broadcast or sprinkle the chemicals onto the water surface. This method may cause chemically-induced spa surface blistering (chemical abuse).

Bather Load

"Bather Load" is the term used to describe the number of people using a spa, combined with the length of usage, and the frequency of usage. All these factors have a great effect on the spa water. The higher the bather load, the more chemicals need to be added and a longer filtration time will be needed.

Recommendations are designed for spas with average bather load (3 to 4 people, 15 minutes of usage, three times a week at 100 degrees) If your bather load exceeds these guidelines, and you experience water quality problems, increase the amount of filtration first, (go to the next higher filtration number) then if water quality is still not adequate, consult the advice of your Cal Spas dealer for additional chemical or system recommendations. Be sure to give them your bather load information.

Pure Cure™ Water Sanitizer

The Pure Cure™ water sanitizer is an optional water purification system installed at the factory. It eradicates germs in the water that are resistant to chlorine-based chemicals using high intensity UV light. Although the water sanitizer works automatically with your spa, you will still need to test for chlorine or bromine and occasionally replenish it to return the sanitizer level to the baseline. See page 25.

For spas without a circulation pump, pump 1 will run at low speed and the water sanitizer will run during filtration.

For spas with a circulation pump, the water sanitizer will run with the circulation pump.

The spa's control system is factory-programmed with one filter cycle that will run in the evening when energy rates are often lower. The time and duration of the filter cycle can be set according to your needs. In addition, a second filter cycle can be enabled. Filtration time may need to be increased with heavy bather load.

See instructions for setting filtration cycles on page 14.

The water sanitizer is virtually maintenance-free. Once a year the UV light needs to be replaced. See page 40 for instructions. **However, the water sanitizer is not a user-serviceable item and maintenance must be performed by a spa technician. Have your service technician consult the manufacturer's instruction and service manual.**

Ozonator

The ozone generator releases ozone into the spa water. You will still need to test for chlorine or bromine and occasionally replenish it to return the sanitizer level to the baseline. See page 25.

For spas without a circulation pump, pump 1 will run at low speed and the ozonator will run during filtration. You will need to increase your filtration to a minimum of six hours per day.

For spas with a circulation pump, the ozonator will run with the circulation pump.

The spa's control system is factory-programmed with one filter cycle that will run in the evening when energy rates are often lower. The time and duration of the filter cycle can be set according to your needs. In addition, a second filter cycle can be enabled. Filtration time may need to be increased with heavy bather load.

See instructions for setting filtration cycles on page 14.

Always make sure water diverter valves are turned all the way to the left or right and never left in the center position during filtration cycles. When the diverter valve is in the center position, there is not enough suction from the pump in order to inject ozone into the spa. The ozonator will generate ozone, but it will not be injected into the water.

Troubleshooting Water Clarity Problems

Problem	Probable Causes	Possible Solutions
Cloudy Water	Dirty filter	Clean filter and run jet pump
	Excessive oils / organic matter	Shock spa with sanitizer
	Improper sanitization	Add sanitizer
	Suspended particles / organic matter	Adjust pH and/or alkalinity to recommended range
Water Odor	Overused or old water	Drain and refill the spa
	Excessive organics in water	Shock spa with sanitizer
	Improper sanitization	Add sanitizer
Chlorine Odor	Low pH	Adjust pH to recommended range
	Chloramine level too high	Shock spa with sanitizer
Musty Odor	Low pH	Adjust pH to recommended range
	Bacteria or algae growth	Shock spa with sanitizer – if problem is visible or persistent, drain, clean and refill the spa
Organic Buildup / Scum Ring Around Spa	Buildup of oils and dirt	Wipe off scum with clean rag – if severe, drain the spa, use a spa surface and tile cleaner to remove the scum and refill the spa
Algae Growth	High pH	Shock spa with sanitizer and adjust pH
	Low sanitizer level	Shock spa with sanitizer and maintain sanitizer level
Eye Irritation	Low pH	Adjust pH
	Low sanitizer level	Shock spa with sanitizer and maintain sanitizer level
Skin Irritation / Rash	Unsanitary water	Shock spa with sanitizer and maintain sanitizer level
	Free chlorine level above 5 ppm	Allow free chlorine level to drop below 5 ppm before spa use
Stains	Total alkalinity and/or pH too low	Adjust total alkalinity and/or pH
	High iron or copper in source water	Use a stain and scale inhibitor
Scale	High calcium content in water – total alkalinity and pH too high	Adjust total alkalinity and pH – if scale requires removal, drain the spa, scrub off the scale, refill the spa and balance the water
		Use a stain and scale inhibitor

Bromine Generator

The bromine generator automatically generates and releases free bromine into the spa water. You will still need to test for bromine and occasionally adjust it to return the bromine level to the baseline.

Start-up/Operating Instructions

Be certain that you start with a clean spa. It should be free of contaminants and other residues that can accumulate on the sides and/or around the jets. It is also important to only use spa cleaning products that have **no phosphates** or phosphonic acids since phosphates will deplete free bromine and are super-food for algae. Always start your spa with a clean filter before filling with water.

If the water source is "well water" or a non-municipal water source, have your water tested for Total Dissolved Solids (TDS) and metals. Water with high TDS is likely to have higher metal content and will need a metal remover to decrease the metals and ensure a successful start. This test can be done by your local spa dealer. The ideal range for your start-up TDS is between 50 and 200 ppm - mg/L. If TDS from your source water is above 500 ppm, a metal remover is strongly recommended.

DO NOT FILL THE SPA WITH SOFT WATER.

- Using your PURE FILL Spa Pre-Filter, fill your spa with water to the recommended level (six inches below the lip of the spa) and **DO NOT FILL WITH WATER FROM A "RESIDENTIAL WATER SOFTENER."**
- Before starting the system, balance your water chemistry to ensure a successful start up. Ideal ranges are as follows:

	Ideal Range	
	Minimum	Maximum
pH	7.2	7.6
Total alkalinity	80 ppm	120 ppm
Calcium hardness	150 ppm	250 ppm
Phosphates	0 ppb	30 ppb

Use the phosphate test kit included with your system. Bromide residuals will be significantly reduced if phosphate levels are high. If phosphates are detected, purchase a phosphate remover and follow the directions accordingly. **Any** phosphates in your spa will reduce bromine levels.



- Determine the level of "NaBr" (Sodium Bromide) required for your spa size. NaBr should be added at a rate of 1.2 lbs per 100 gallons or approximately 1300-1500 ppm.

Example: For a 500 gallon spa add approximately 6 lbs of NaBr. **1.2 lbs x (5) 500 gallons = 6lbs NaBr.**

- Turn the jets on high speed. Sprinkle the NaBr across the surface of the water to evenly distribute the NaBr in the spa and circulate for 30 minutes.
- Test the Sodium Bromide concentration with the Tru-Blu NaBr test kit. The correct amount of NaBr will secure a reading of between 1300-1500 ppm.
- Adjust the filtration time to circulate for 8 hours every 24 hours on a 2 speed pump.
- For a spa between 300-500 gallons, start at a power level of "6" and then press the "boost" feature. This will accelerate the production of bromine for 8 hours. Wait for proper bromine levels before entering the spa.
- Always keep your bromine level between 3-5ppm. Test the bromine level after 24 hours and adjust the power setting accordingly. An occasional heavier bather load may require the "boost" feature.

Maintaining the Bromine Level

Always keep your spa or hot tub water in balance. Maintaining the pH and the alkalinity is part of being a spa owner.

The bromine generator requires you to determine your power setting based upon your circulation time and your spa usage. It requires a minimum of eight hours of circulation per day. If the spa is not circulating, the bromine generator is not generating bromine. If you find that you are having trouble maintaining the desired level, make sure the spa is circulating the required amount.

A spa that is frequently used will require a higher power setting. If you have a bromine reading that is too high or too low, adjust the **DECREASE / INCREASE** control accordingly. Depending on the amount usage, circulation time, and type of spa, each spa owner's setting will be different.

The bromine generator can go up to 12 months before a drain and fill is required, unlike non-equipped spas that require it every three months. This is because the bromine generator does not add unwanted chemical by-products like traditional chemicals do.

Sodium bromide is not the only contributor to the TDS count in your water. Over time, the TDS count in your water will rise (from such things as residuals from other chemicals and minerals, and unfilterable material). Test the TDS every few months to make certain it stays within range.

Shower prior to entering any hot tub or spa. This will help prevent phosphate contamination and reduce the demand on the bromine.

Shocking your tub is recommended after heavy bather load.

Intelligent Controller Codes for the Bromine Generator



LC (Low Conductivity) will appear when the unit detects that the conductivity is below the minimum level. At start-up, you will experience this if you have not added the Sodium Bromide. Check the Sodium Bromide level in the water and add the appropriate amount per your spa. If the NaBr level is correct, the cell may be experiencing scaling. In this case, you will want to clean the cell. Please consult with your spa dealer for further information.



bSt (Boost) will appear when the BOOST feature is on. Depressing this key once will increase the bromine production to twice that of the last bromine production setting for the next *accumulated eight hours of pump circulation time*. The BOOST cycle should be depressed after heavy bather load or usage.



OE (Open Element) will appear if the system controller is unable to detect a connection to the electrode cell. You may see this if the electrode is not connected properly, there is inadequate water flow, or the cell is not functioning due to unknown circumstances. This may require that the cell be evaluated and possibly cleaned of scale build-up or even replaced. If this happens, please consult with your spa dealer.

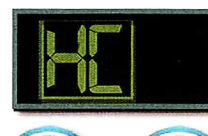

HC (High Current) will appear when the TDS (Total Dissolved Solids) is too high resulting in High Current at the electrode cell. If this reading appears at or near start up of your system, check your source water for TDS and proper NaBr readings. If this reading appears after an extended period of operation, draining 25% of the water and refilling can help reduce TDS levels. If "HC" remains present, consult with your spa dealer for a comprehensive water analysis and recommended course of action.

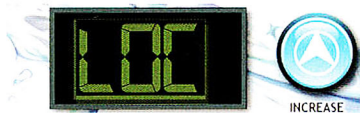

LOC: Press increase for 3 seconds to unlock

LOC (Locked) Your TopSide controller includes a "LOC" feature which ensures that the system is "Locked" when not being utilized to manage your Spa's water. Your system will automatically produce bromine when necessary. This feature is simply for your protection. In order to "Unlock" simply depress the "increase" key on your unit for 3 seconds.

Cleaning and Maintenance

Removing and Reseating the Pillows

You can remove the pillows for cleaning and maintenance quickly and easily. This method works for all types of pillows.

Grab the lower edge of the pillow with both hands firmly and pull up. As you do this, the pillow inserts will pop out of the holes.

Reseat the pillows by aligning the pillow inserts with the holes and striking the pillow hard enough to insert the pegs back into the holes.

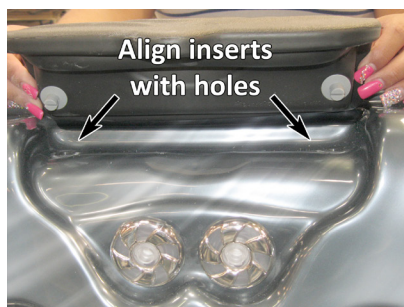

Jet Removal and Replacement

Jets can be easily removed for cleaning.

Screw-in jet removal

Grasp the outer rim of the jet and turn it counter-clockwise. The jet will unscrew from the fitting until it is free.

To replace the jet, place it in the fitting and turn it clockwise until it is snug in place and it can be rotated freely about half a turn. Do not overtighten the jet.

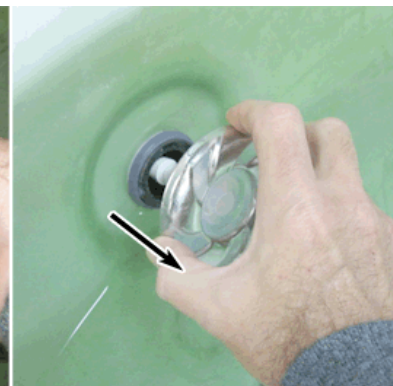
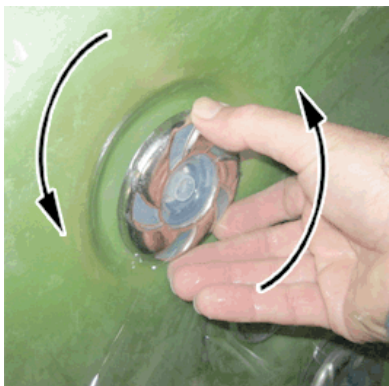

Snap-in SQR jet removal

Grasp the outer rim of the jet and turn it counter-clockwise until it completely stops. You may feel it slightly loosen pop out a bit from the fixture. Pull the jet out from the jet fixture. The jet will be very snug and may require some force to remove it. **DO NOT PRY OUT JETS.**

To replace any jet, place it in the fitting and turn it clockwise until it snaps in and can be rotated freely about half a turn. Do not overtighten the jet.



Draining Your Portable Spa

Your spa should be drained every four to six months for cleaning and maintenance and refilled with fresh tap water. See page 39 for instructions on cleaning the shell, cover, and pillows. See page 5 for instructions on refilling your spa. Before you begin, turn off power to the spa at the breaker and remove all filters.

1. Locate your drain.

For spas with drain inside the spa

Using a Phillips screwdriver, remove the screws to the access panel and open it. Locate hose ending with the 3/4 inch hose-bib fixture as shown below.



For spas with cabinet-mounted drain

Pull the knob out of the cabinet. The cabinet drain is screwed into the drain pull knob.



2. Remove the cap.

Make sure the valve is in the closed position, then unscrew and remove the cap. Unscrew the cap.

For spas with drain inside the spa

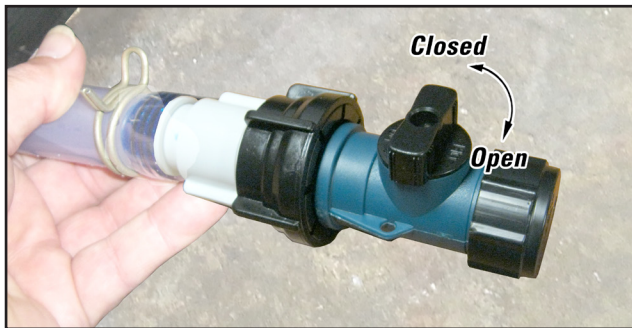

For spas with cabinet-mounted drain



3. Connect valve to a garden hose.

Attach a garden hose to the hose-bib fixture. Place the other end of the garden hose where you would like the water to drain.

4. Drain the spa.

Turn the valve on the hose-bib fixture to open the drain. When the spa has drained completely, turn the valve on the hose-bib fixture, remove garden hose, and replace the cap.

For all spas

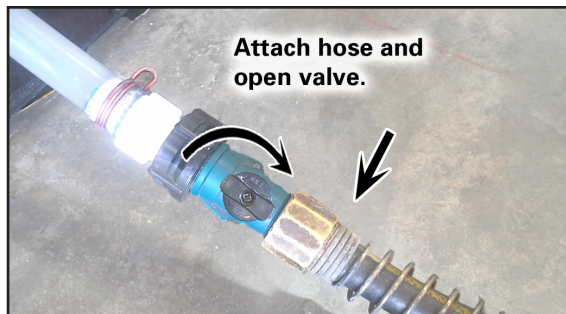

Winterizing (Cold Climate Draining)

In many areas of the country, the temperature drops below 32°F (0°C). We recommend that you always have your spa full of water and running at normal spa temperatures (80°F to 100°F, 26.7°C to 37.8°C). This will help reduce the risk of freezing in your spa and your spa's equipment.

Warning: If you find the need to drain your spa, be aware of the potential of freezing in your spas equipment and plumbing. Even if the directions below are followed perfectly, there is no guarantee that your spa will not suffer freeze damage. Freeze damage is not covered by your warranty.

1. Remove the filter baskets and filters.
2. Drain your spa completely as described in the instructions above.
3. Vacuum water from the spa's main drain and from the jets with a wet/dry vacuum.
4. Open the bleeder valves on the pumps.
5. Disconnect the unions from both sides of all pumps.
6. Blow any remaining water out of the jets and equipment area with the wet/dry vacuum.
7. When the spa has completely finished draining, close the bleeder valves and re-connect the unions on all pumps. Replace the filters and filter baskets.
8. Cover your spa with a good spa cover and an all-weather tarp to ensure that neither rain nor snow enters the spa.

Cleaning and Replacing the Filter

Filtration is one of the most important steps you can take to ensure clean, clear water. It is far less expensive to fix water clarity problems by filtering your spa than by using excessive amounts of chemicals, excessive filtration times, or by water replacement.

See the section "Cleaning the Filter" on page 28 for more information.

Set the spa in Hold Mode before you remove the filter. Hold Mode pauses all spa operations for 60 minutes for service functions like cleaning or replacing the filter. See page 13 for instructions on using Hold Mode.

1. Remove the filter by unscrewing it and pulling it up and out.
2. Place the dirty filter into a bucket of water deep enough to cover the filter. Add 8 oz. of liquid filter cleaner to the bucket of water.

Note: It is a good idea to keep a spare filter to use in the spa while the dirty filter is being deep cleaned. This way, you can rotate the filters and both will last longer.

3. Soak the filter for a minimum of 24 hours.
4. Spray the filter with a water hose. Spray each pleat carefully.
5. Reinstall the filter. Do not overtighten.

Spa Cover

Important! Keep the spa covered when not in use!

- Covered spas will use less electricity in maintaining your set temperature.
- Covering your spa will protect your spa's finish from the sun's ultraviolet rays.
- You are required to keep the spa covered to maintain warranty coverage.
- Covering your spa helps prevent children from drowning in the spa.

See the manual enclosed with your cover for instructions on mounting the locks and how to lock and unlock the cover.

In addition, while the spa cover is rigid, it is not designed to support any weight. Therefore, as a safety precaution and to preserve the life of your cover, you must not sit, stand, or lie on it, nor should you place objects of any kind on top of it.

Vacation Care

You can leave your spa unattended for up to two weeks if you follow these instructions.

ALWAYS lock your cover using the cover locks if you plan to be away from home and the spa is filled with water.

1. Select the Low Range temp choice used for vacation mode. (See instructions on page 11 for vacation setting.)
2. Following the water quality instructions starting on page 23, adjust the pH.
3. Shock the water (add either chlorine or bromine sanitizer).
4. When you return, check and adjust the pH and shock the water.

If you will not be using your spa for longer than 14 days and a spa maintenance service is not available, we strongly recommend you drain or winterize your spa.

Cleaning Your Spa

Spa Cover and Pillows

Due to the constant punishment your spa cover and pillows receive, you should protect them by applying a vinyl and leather cleaner as part of your monthly maintenance plan. Use a product that is specifically designed to protect spa covers and pillows from chemical and ultraviolet light damage without leaving an oily residue behind that is normally associated with common automotive vinyl protectants.

Warning: Do not use automotive vinyl protectants on spa covers or pillows. These products are generally oil-based and will cause severe water clarity issues that are difficult to correct.

Spa Shell

Each time you drain your spa, before you refill it you should clean your spa shell with an all-purpose cleaner and apply a coat of surface protectant.

Use a low detergent, non-abrasive cleaner specifically formulated to clean the spa without damaging its acrylic finish.

Use a non-oil based surface protectant that is specifically formulated to protect the spa's finish from the chemicals and minerals associated with normal spa use.

Changing the UV Lamp



CAUTION: Always turn off power to the spa at the GFCI prior to any maintenance.

Note: Periodically you should check the light on the transformer for the UV light system. The transformer is mounted in the spa equipment area close to the system control box. When it is operating normally, the light will be green. When it requires maintenance, it will be red. This usually happens when the UV lamp needs replacing. The UV lamp is a wearable part that needs replacing about once a year.



1	Water-proof strainer
2	Aluminum nut
3	Lamp socket and lead wire
4	Germicidal UV lamp
5	Rubber O-ring
6	Quartz thimble
7	Chamber
8	Clip
9	Ballast

See page 45 for part numbers for replacement parts.

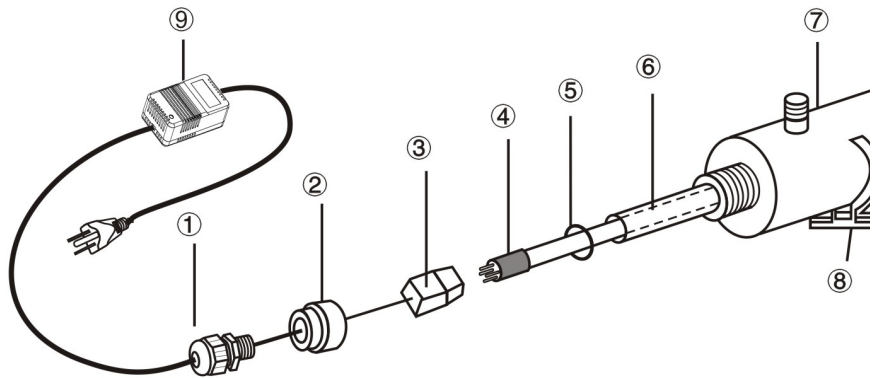

To remove the UV lamp

1. Disconnect power.
2. Turn water off and open down stream of system to relieve pressure.
3. Cut the tie wrap that attaches the UV lamp chamber to the spa frame.
4. Remove the water-proof strainer (1) and unscrew the aluminum nut (2).
5. Pull out the lamp (4) approximately 2" from the chamber (7).
6. While holding the lamp end, remove the lamp socket (3) from the end now exposed.
7. Remove the lamp from the chamber.
8. Remove the O-ring (5) from the end of the quartz thimble (6).
9. Remove the quartz thimble.

To reinstall the replacement UV lamp, follow these steps in reverse.

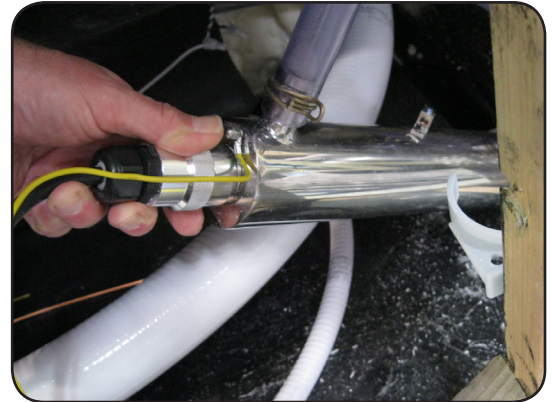

When replacement UV lamp has been installed, conduct a final leak check:

1. Restore power to the spa at the GFCI.
2. Turn on the pump and let water run for five minutes to check for leaks.

Using the Digital Media Locker

The digital media locker is fully integrated with your Cal Spa. It will accommodate any digital device, such as iPhones, smart phones, and MP3 players, that is USB or Bluetooth capable.

The docking station comes with its own owner's manual. It describes parts included, installation, and proper use. Owners of this system must read the manufacturer's instructions prior to operating this unit. The instructions are shipped inside the docking station behind the remote control.

The instructions contained in this manual describe only basic functions. See the manufacturer's operating instructions for other features and functions.

Although the media locker features a locking door with seals, it is **water resistant** and **NOT waterproof**. You must take every precaution to keep the interior of the media locker dry.

- Make sure that hands are dry before coming in contact with the media locker.
- Always CLOSE AND LOCK the protective door.

Water damage caused by negligence or improper use is not covered under warranty.

Note: The digital media locker comes with a remote control and does NOT INCLUDE an MP3 player such as an iPod.

If you have trouble pairing the devices:

- Re-read the instructions and follow them carefully. You may have missed an important detail.
- Make sure the red power light inside the docking bay is OFF before you begin.
- PRESS and HOLD the **Mode** button on the remote until it reads PAIR. Do not release the **Mode** button.
- Do not press the **Power** button inside the docking station until the remote reads PAIR.
- Press and hold the **Power** button for **NO MORE** than five seconds. Otherwise, the devices will not pair.

Aquatic AV AQ-DM-5UBT

Synchronizing (Pairing) the Remote Control with the Media Locker

Before you can use the remote control with the docking station, they need to be synchronized, or paired. Follow the simple instructions below.

1 Before you begin, make sure the docking bay is **OFF**. If the red **Power** light inside the docking bay is on, press it once to turn it off.



2 Press the red **Power** button on the remote.



3 Press and hold the **Mode** button on the remote. The display on the remote will read PAIR.

4 While still holding the **Mode** button, press and hold the **Power** button inside the docking station for five seconds.



The display on the remote will read WELCOME or show a mode position such as RADIO.



When the remote and docking bay are paired, the power button light will turn blue.

If they do not pair the first time, repeat these four steps until it is successful.

Listening to Devices

There are three ways to connect your device to the media locker: With the USB connection, Bluetooth connection, and the auxiliary input.

1. Connecting via USB

The Aquatic AV digital media locker comes with one USB connector for Apple devices. If you have another kind of device, you will need to supply your own USB connector, such as the type shown below.

1. Attach your device to the USB cable inside the digital media locker using the appropriate USB connector.



Apple USB connector



USB micro B connector

2. Secure the device with the anchor straps.
3. Close and lock the media locker's protective door.
4. Press **POWER** on the remote control or Power button on the locker to turn it ON.
5. Press **MODE** on the remote control to select USB mode. Use the buttons as shown in the remote function chart.

Note: When USB devices are connected to the USB input, the device's battery will charge.

Search for Songs and Playlists

Apple devices

1. Press **SEARCH** to enter iPod searching mode.
2. Once in searching mode, the remote will display 'Playlist'. Continue to press **SEARCH** to scroll through the search modes below:
 - 1) Playlist 2) Artist 3) Album 4) Song 5) Genre 6) Composer 7) Audio Book
3. Press **PLAY/PAUSE** To select the desired search mode.
4. Press **Volume UP/DOWN** to scroll through your media in the selected search mode.
5. Once you find the desired media, press **PLAY/PAUSE** to make your selection. If your selection is a song, it will begin to play. If you select a playlist, artist, album, genre, composer or audio book, the songs in the selected folder will be visible. Press **PLAY/PAUSE** to play the desired song within the folder.

Other USB Devices

1. Press **SEARCH** to enter the USB searching mode.
2. Press **Volume UP/DOWN** to scroll through the folders on your USB device. To select a folder, press the **PLAY/PAUSE** button.
3. Press **Volume UP/DOWN** to scroll through the songs in the folder and press **PLAY/PAUSE** to play the desired song.

2. Connecting via Bluetooth

1. Switch on your Bluetooth device.
2. Select 'AQUATIC AV' from the list of available devices to pair (no password is needed).

Only one Bluetooth device can be paired with the Digital Media Locker at any time.

Bluetooth mode will be activated once a Bluetooth device is linked. Play the song from device and the sound will play through the Digital Media Locker.

- Press **PLAY/PAUSE** to play or pause the song.
- Press **FAST REWIND** or **FORWARD** buttons to play previous/next song file.

Track and volume can be controlled directly from your Bluetooth device, remote control or door controls.

3. Connecting via Auxiliary Input

When you connect your device via the auxiliary input, you play media directly to the audio input of the media locker. The remote control can not control your device when it is connected through the auxiliary input. You will need a 3.5 mm audio connector as shown below.

1. Connect your MP3 device to the 3.5 mm jack input.
2. Secure the device with the anchor straps.
3. Close and lock the media locker's protective door.
4. Press **POWER** on the remote control or the **POWER** button on the locker to turn it ON.
5. Press **MODE** on the remote control to select 'AUX IN' mode.

Only one auxiliary input (3.5 mm jack) can be used at any one time.



3.5 mm audio cable

Listening to FM Radio

Press **MODE** on remote control to switch to FM radio mode. If this is the first time you listen to FM radio, the default frequency will be 87.5MHz, as shown on the remote LCD.

To scan or seek FM radio channels, press **FAST REWIND** or **FAST FORWARD** to seek another station. Press and hold either **FAST REWIND** or **FAST FORWARD** for manual tuning back or forward.

To save the current radio station into memory, press and hold the **1, 2, or 3** button for more than 2 seconds. The station will be stored to that button. Press the **1, 2, or 3** button to listen to the preset station.

Closing and Locking the Door

Always CLOSE and LOCK the media locker door after you place or remove a media device inside it.

Slide the clasp down to lock the door as shown at right. Make sure the door is firmly pressed into the watertight seal before you slide the lock into place.



Water damage caused by negligence or improper use is not covered under warranty.

Remote and Keypad Functions

All of the functions on remote control and the keypad on the media locker's door are identical.

For a detailed description of all key functions, see the manual for the Aquatic AV media locker.

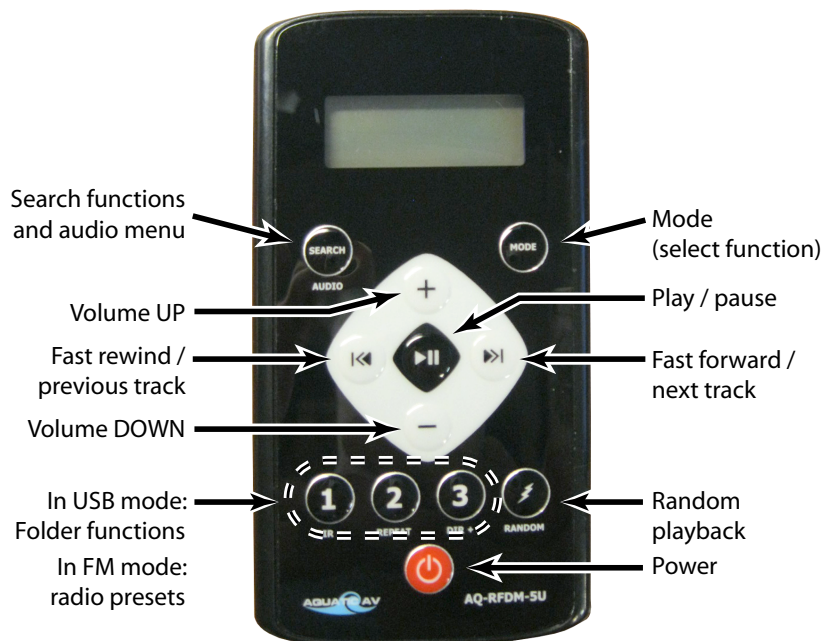

Using the Freedom Sound System

The Freedom Sound System™ entertainment option contains a Bluetooth-enabled speaker system that is available for certain Cal Spa models. Any Bluetooth-enabled device can be used to play audio through your spa. 

Before you can use the sound system, you need to pair the Bluetooth module with your device. The Bluetooth module is installed within the spa cabinet. Everything can be done with your device. The example shown below is from an iPhone device. Your device may appear differently. Before you begin, make sure Bluetooth is enabled on your device.

1. Select Bluetooth from your device's option list.
2. Select **SWA8-1BT...** from the list of available devices to pair.
3. Allow your device to pair with the spa's Bluetooth module.
4. When the devices have been connected, the device **SWA8-1BT...** will be highlighted.

Only one Bluetooth device can be paired with the Freedom Sound System™ at any time.

Once your device is paired and connected, all sounds from your device will be played through the sound system, including system sounds and telephone.

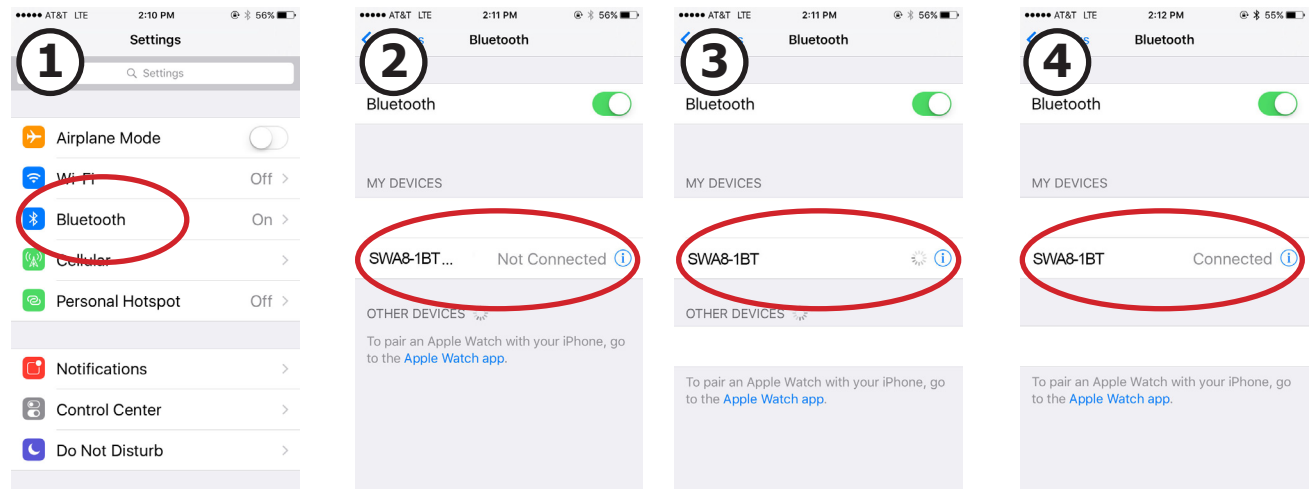



Appendix

Replacement Parts

Please visit www.quickspaparts.com to order your replacement parts.

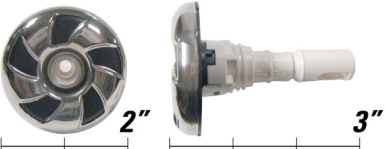
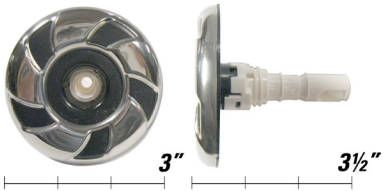
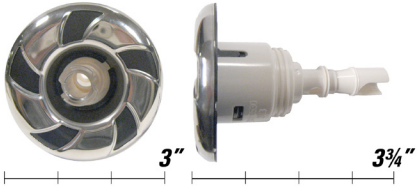

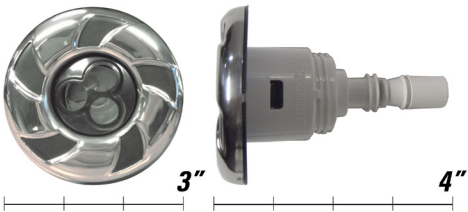
Note: All Cal Spa models use a combination of screw-in and snap-in jet inserts where removable jets are used.

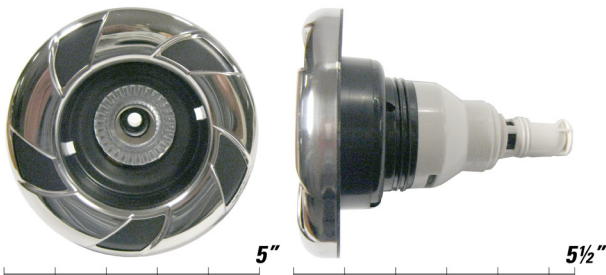
Screw-in Jet Inserts	
Description	Used by
ELE 2" Euro No Eyeball PLUCS2295021SL 	Escape Escape+
ED 2" Euro Directional PLUCS2295051SL 	Escape Escape+
MED 3" XL Cluster Storm Directional PLUCS2295031SL 	Escape Escape+
mfd 3" Micro Flow Directional PLUCS2295061SL 	Escape Escape+

Screw-in Jet Inserts	
Description	Used by
MM 3" Mini Storm Massage PLUCS2297061SL-8 	Escape Escape+
MFD 3.5" Maxi Flow Directional PLUCS2295091SL 	Escape Escape+
PSD 5" Power Storm PLUCS2295131SL 	Escape Escape+

Please visit www.quickspaparts.com to order your replacement parts.

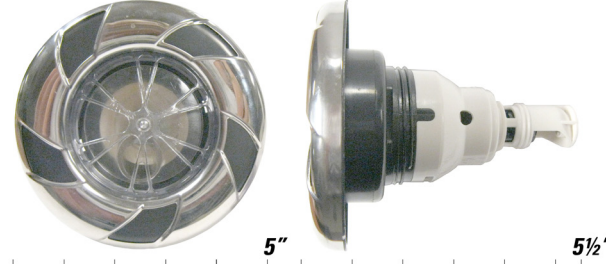
Screw-in Jet Inserts	
Description	Used by
ET 2" Cluster Storm Twin PLUCS2295161SL 	Escape Escape+
MMP 3" Mini Multi-Massage PLUCS2295171SL 	Escape Escape+
PSTR 5" Power Storm Twin Roto PLUCS2295181SL 	Escape Escape+
MMP 5" Power Storm Riffed PLUCS2295141SL 	Escape Escape+

Screw-in Jet Inserts	
Description	Used by
PST 5" Power Storm Wagon Wheel PLUCS2295191SL 	Escape Escape+
T 5" Tornado Adjustable PLUCS2295201SL 	Escape Escape+

Please visit www.quickspaparts.com to order your replacement parts.

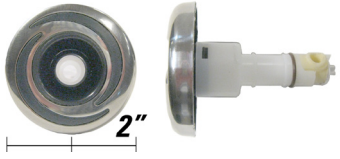
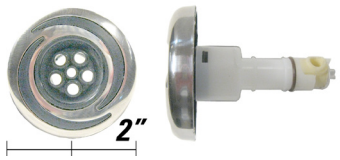
Snap-in SQR Jet Inserts	
Description	Used by
<p>SQN halo, 2" directional neck jet, 100% shut-off</p> <p>Halo with gray eyeball</p> <p>PLU29923-114-000</p> 	<p>Used by: Escape Escape+ Platinum Fitness</p>
<p>SQN halo, 2" neck jet, 100% shut-off</p> <p>Halo w/ graphite gray center</p> <p>PLU29520-611-500</p> 	<p>Patio Patio+</p>

Snap-in SQR Jet Inserts	
Description	Used by
<p>SQ2D, 2" euro jet directional</p> <p>Halo w/ graphite gray eyeball</p> <p>PLU29520-011-500</p> 	<p>Patio Patio+</p>
<p>SQ3D, 3" directional mini jet</p> <p>Halo w/ graphite eyeball</p> <p>PLU29530-111-500</p> 	<p>Patio Patio+</p>
<p>SQ3M halo, 3" mini massage jet</p> <p>Halo w/ graphite center</p> <p>PLU29530-141-500</p> 	<p>Patio Patio+</p>
<p>SQ4D, 4" directional maxi flow jet</p> <p>Halo w/ graphite gray eyeball</p> <p>PLU29540-111-500</p> 	<p>Patio Patio+</p>

If you need jet bodies, go to www.quickspaparts.com or refer to the Cal Spa Replacement Parts Catalog, which can be downloaded from www.calspas.com/replacement-parts.

Please visit www.quickspaparts.com to order your replacement parts.

Snap-in SQR Jet Inserts	
Description	Used by
SQ5R, 5" rotational jet Halo w/ graphite gray eyeball PLU29550-081-500 	Patio Patio+
Jets	
Flex Jet PLU23512-311-100 	
Duo Jet PLU23512-321-100 	
Precision Jet PLU2312-331-100 	

Snap-in SQR Jet Inserts	
Description	Used by
Hio, Roto, 3" pro-loc PLU29530-121-500 	Patio Patio+
Hio, Roto, 3.5" pro-loc PLU29530-031-500 	Patio Patio+
MM, 7" ultra blaster Stainless steel w/ black center PLU23570-142-400 	Escape



If you need jet bodies, go to www.quickspaparts.com or refer to the Cal Spa Replacement Parts Catalog, which can be downloaded from www.calspas.com/replacement-parts.

Please visit www.quickspaparts.com to order your replacement parts.

Water Diverter Valves	
Diverter Valve 2" Titanium Black (CS600303T1-TT) PLU21300465	
Diverter Valve 1" Titanium Black (CS600426T1-TT) PLU21300453	
Diverter Valve 1 1/2" On/Off ASSY (600-4601) PLU21100045	

Air Control Valve	
Air Control with Titanium Black CS660350T1-TT PLU21300504	
Aquatic Air Therapy (AAT) Air Control PLU25059-211-00	

Drains	
Drain Super Hi Flo Suction 2 1/2" Black (640-3581LGV) PLU21400146	
Low Profile Drain 3/4" Black (640-0511) PLU21400401	

Weir Skimmers	
Weir Skimmer Gate, Black Small, with Cal Spas Logo (#CS550-0281) PLU21600284	 10 3/4" 12 1/4"
Skimmer Weir Gate, Black, Small, No Logo (#550-9021) PLU21600285	 10 3/4" 12 1/4"
Weir Skimmer Gate, Large, Cal Spas Logo (#CS55000391) PLU21600294	 10 3/4" 19 7/8"

Pillows	
Cascade Pillow No Insert Black ACC01401031	 0 11"

If you need jet bodies, go to www.quickspaparts.com or refer to the Cal Spa Replacement Parts Catalog, which can be downloaded from www.calspas.com/replacement-parts.

Please visit www.quickspaparts.com to order your replacement parts.

Pillows

Infinity Pillow Ribbed Black

ACC01401051



Infinity Pillow Plain Black

ACC01401061



Y Pillow recess

ACC01401101



Filters

Note: All filters are female threaded.

50 sq ft

FIL11100208

PWW50L-M



75 sq ft

FIL-PCAL77P4-M



Teleweir Skimmers

50 square foot teleweir skimmer:



Filter attaching cap assembly

FIL11700013

Filter skimmer inner pipe

FIL11700012



75 square foot teleweir mega skimmer:



Filter attaching cap assembly

FIL11700025

Filter skimmer inner pipe

FIL11700026



Waterfalls

Cascade II Waterfall Black textured with valve and logo 12-3/8" '14



PLU21800825TEX

Cascade II Waterfall Curved Black Textured with Valve and Logo 12-3/8" '14





PLU21800828

If you need jet bodies, go to www.quickspaparts.com or refer to the Cal Spa Replacement Parts Catalog, which can be downloaded from www.calspas.com/replacement-parts.

Please visit www.quickspaparts.com to order your replacement parts.

LED Lights	
<p>LED mini DCU controller (P1309) LIT16100626</p>	
<p>2-LED light string LIT16100620</p>	
<p>4-LED light string LIT16100621</p>	
<p>Interior light with logic LIT16100625</p>	
<p>LED light string jumper, 46 inches, daisy chain ELE09902531</p>	

<p>Knob, 1/4-20 FTI, Black, UV Blend (#TRIAD-30), used for door panels on steel frame cabinets FIX12600096</p>	<p>Side</p>  <p>Bottom</p> 
---	---

Pure Cure™ UV Water Sanitizer	
<p>Pure Cure complete system (Wonder PP-1) LIT16000380</p>	
<p>Germicidal UV lamp (T515) LIT16000381</p>	
<p>Rubber O-ring (D24.5) LIT16000384</p>	
<p>Quartz thimble (24.5X350) LIT16000383</p>	
<p>Ballast (UV-3) LIT16000382</p>	
<p>Clips LIT16000385</p>	

Replacement Cabinet Panels

The complete selection of replacement cabinets for all models is very extensive and too lengthy for this owner's manual. To order replacement panels for your spa, visit www.quickspaparts.com.

Please visit www.quickspaparts.com to order your replacement parts.

Covers

All spa covers are designed with a tapered height, angling downward from the center to the sides to drive off rain and prevent water from pooling. The covers listed below are filled with either 1.5 lb or 2.0 lb foam.

Standard

4" - 2.5"

1.5 Lb. foam

Deluxe

5" - 3"

2.0 Lb. foam

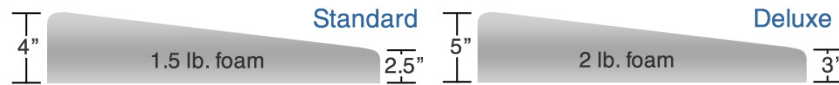

	Gray Standard	Slate Standard
54" x 78" Fits spa models: PZ-517L, PPZ-525L	COV5478S53G-CC	COV5478S53S-WN
64" x 84" Fits spa model: PPZ-537L	COV6484S53G-CC	COV6484S53S-WN
72" x 72" triangle Fits spa models: PZ-617T, PPZ-628T	COV7272TRS53G-CC	COV7272TRS53R-WW
78" x 84" Fits spa models: PZ-621L, PPZ-631L	COV7884S53G-CC	COV7884S53S-WN
78" round Fits spa model: P2511R	COV78RDS53G-CC	COV78RDS53S-WN
87" x 87" Fits spa model: EP-760DL, EC-754DL	COV8787S53G-CC	N/A

	Gray Standard	Gray Deluxe	Slate Standard	Slate Deluxe
93" x 130" Fits spa model: EC-947E	N/A	COV93130D53G-CC	N/A	N/A
84" x 84" (7 foot spas) Fits spa models: P2-722L, P2-722B, PP-732L+, PP-732B+, EC-735L, EC-735B, EC751L, EC751B, EP-761L, EP-761B, PL-760L, PL-760B, PPL7L+	COV8484S53G-CC	COV8484D53G-CC	COV8484S53S-WN	COV8484D53S-WN
93" x 93" (8 foot spas) Fits spa models: EC-835L, EG835B, EC-851L, EC-851B, EC-852L, EC-864L, EC-864B, EP-861L, EP-864B, PL-860L, PL-861B, PL-880L, PL-881B, PPL-8B+	COV9393S53G-CC	COV9393D53G-CC	COV9393D53S-WN	COV9393D53R-WW

Basic Troubleshooting

The troubleshooting guidance provided here is intended to cover the most common problems a spa owner may encounter. For more in-depth troubleshooting, go to www.calspas.com/troubleshooting.

Symptom	Possible Solutions
---------	--------------------

Problems starting up

Pump won't prime	See priming instructions on page 8.
Breaker keeps shutting off	Reset the GFCI breaker. If this continues, contact your dealer or a qualified spa technician.

Power and system problems

System won't start up or breaker keeps shutting off	Power may be shut off. Turn on GFCI circuit breaker. If this continues, contact your dealer or a qualified spa technician.
Control panel doesn't respond	Turn on or reset the GFCI circuit breaker. If this does not solve the problem, contact your dealer or a qualified spa technician. If you hear the pump running but the control panel doesn't respond, contact your dealer
Spa does not turn off	Spa may be trying to heat up. Check if spa is in Ready or Rest mode (see page 12) In cold climates, if spa is not equipped with full foam or any kind of insulation, it will try to maintain the set temperature. Set the spa to low temperature range and set the temperature to 80°F. Spa may be in filter cycle. If it is, this is normal and no adjustment is necessary.
Message on the control panel	There may be a problem. See Diagnostic Messages on page 16.

Heat problems

Spa water does not get hot	Spa may be in low temperature range. Set the spa to high temperature range. The filter may be dirty or may need to be replaced. Clean or replace the filter. The water level may be too low. Fill the spa with water level at 4 to 6 inches from the top. The temperature is not turned up high enough. Raise temperature on topside control. Cover the spa. The cover will keep heat in the spa and help keep heat from escaping. Make sure cover is on at all times when spa is not in use. The heater element may be old, deteriorated, coated with scale, or defective. Contact your dealer for more assistance. The gate valves may be partially or completely closed. NEVER OPERATE YOUR SPA WITH THE GATE VALVES CLOSED!
----------------------------	---

Symptom	Possible Solutions
Spa overheats - temperature greater than 110°F / 43°C	<p>Overheating can occur during summer months and may not necessarily indicate a malfunction. When it occurs, a message code may also appear on the control panel.</p> <p>Temperature may be set too high. Turn the set temperature down to a lower temperature.</p> <p>Filtration time may be too long. Turn the filtration cycles down during the warm months.</p> <p>The spa may not be properly ventilated. Make sure the front of the spa is not blocked to allow air flow.</p> <p>High speed pumps may have been running too long. Limit pump running time to no more than 15 to 30 minutes.</p>

Water pressure problems

Low water pressure	<p>Jet valves may be partially or fully closed. Open the jet valves.</p> <p>Filter cartridge may be dirty. Clean or replace the filter.</p> <p>Pump may have airlock. Remove airlock by priming spa (page 8)</p> <p>The suction fittings may be blocked. Remove any debris that may be blocking them.</p> <p>The filter skimmer may be blocked. Remove the blockage.</p> <p>Gate valves may be closed. Open gate valves. Note: Never operate your spa with the gate valves closed!</p> <p>Spa may be running in filtration mode. Press JETS or JETS 1 button to turn on high speed pump.</p>
No water pressure (no water stream from any jets)	<p>Power may be switched off. Turn the power back on.</p> <p>The pump may be defective. After you have tried all other troubleshooting, contact your dealer for assistance.</p>
Jets surge on and off	Water level may be too low. Add water to normal level.

Pump problems

Pump runs constantly – will not shut off	There may be a problem with circuit board. Contact your dealer.
Noisy pump	<p>The water level may be too low. Fill the spa with water level at 4 to 6 inches from the top.</p> <p>Filter cartridge may be dirty. Clean or replace the filter.</p> <p>Pump may have airlock. Remove airlock by priming spa (page 8)</p> <p>The suction fittings may be blocked. Remove any debris that may be blocking the suction fittings.</p> <p>Gate valves may be closed. Open gate valves. Note: Never operate your spa with the gate valves closed!</p> <p>Air may be leaking into the suction line. Contact your dealer for assistance.</p> <p>Debris may be inside the pump. Contact your dealer for assistance.</p> <p>Noise may be a sign of damage. Contact your dealer for service.</p>

Symptom	Possible Solutions
Pump turns off during operation	Automatic timer may have completed its cycle. Press JETS or JETS 1 button to start the cycle again. Pump may have overheated due to the vents on the equipment door being blocked. Make sure the front of the spa is not blocked to allow air flow. The pump motor may be defective. Contact your dealer for assistance.
Pump has a burning smell while running	A burning smell may be a sign of damage. Contact your dealer for service.
Pump does not run	Pump may have over heated. Let it cool for an hour and try operating the spa for a shorter time. Power to the spa may be shut off. Turn on or reset the GFCI circuit breaker. If this does not solve the problem, contact your dealer or a qualified spa technician.

LIMITED WARRANTY

This Limited Warranty is extended to the original purchaser of a Cal Spa brand portable spa manufactured after January 1, 2016 and installed for residential use in the United States of America and Canada. This warranty begins on the date of delivery of the spa, but in no event later than one year from the date of manufacture.

This warranty applies only to these spa lines: →	Patio, Patio+	Escape, Escape +	Special Edition
Shell Structural Warranted against water loss due to defects in the spa shell.	5 years	10 years	10 years
Shell Finish Warranted against blistering, cracking, or delaminating of the interior surface of the spa shell.	2 years	7 years	7 years
Equipment and Controls Electrical equipment components – specifically limited to the pumps, standard titanium heater, and control system – are warranted against malfunctions due to defects in workmanship or materials.	2 years	5 years	5 years
Plumbing Warranted against leaks due to defects in workmanship or materials.	2 years	5 years	5 years
Cabinet - Synthetic, Fiberglass, or Wicker Warranted against defects in workmanship or materials. Normal wear and weathering of the finish will occur naturally over time and are not defects.	1 year	5 years	5 years

Warranties for Other Components

The fuses, headrests, cabinet finish, and filters are warranted to be free of defects in workmanship and material at the time of delivery. The factory installed water purification system is warranted against malfunction due to defects in workmanship or material for one year from the original date of delivery, except for the UV bulb and quartz tube, which are warranted for 90 days from the original date of the spa delivery. All stereo-related components (receiver, speakers, sub-woofer, stereo media locker, power supply, wireless remote control etc.) are warranted against malfunction due to defects in workmanship or material for one year from the original date of delivery. All other factory-installed components not mentioned specifically, including, but not limited to the wood frame, jets, diverter valves, LED lighting systems, filter lids, and mechanical components, are warranted against malfunction due to defects in workmanship and material for two years from the original date of delivery. The spa cover delivered with the spa is warranted for one year for Escape and Special Edition spas, 90 days for Zone, Connect, and New Age spas.

Genuine Cal Spas Parts & Accessories

This Limited Warranty is void if Cal Spas (the "Manufacturer") or its designated representative determines that the spa has been subjected to damage or failure due to installation of aftermarket parts that are not genuine Cal Spas branded parts and accessories. This disclaimer includes, but is not limited to filters, UV bulbs, ozone systems, salt systems, repair parts and other accessories. Genuine Cal Spas brand parts and accessories are built to our highest standards of quality, durability and performance, and they are designed to work with your spa to ensure optimal performance and function.

Performance

This warranty begins on the date of delivery of the spa, but in no event later than one year from the date of manufacture.

To obtain service in the event of a defect covered by this Limited Warranty, notify your Cal Spa dealer or Cal Spas as soon as possible and use all reasonable means to protect the spa from further damage. Upon proof of purchase, a designated service representative will correct the defect subject to the terms and conditions contained in this Limited Warranty. There will be no charge for parts or labor to repair the defect, although providing access to affect the repair is your responsibility as the spa owner. Freight charges for replacement parts is the responsibility of the spa owner. You may be assessed reasonable repairman travel mileage charges.

In the event that the spa is removed to a repair facility for repair and reinstalled, the cost of removal and reinstallation will be your responsibility as the spa owner. If the Manufacturer determines that repair of the covered defect is not feasible, it reserves the right to provide a replacement spa instead, equal in value to the purchase price of the original spa. In such an event, reasonable costs for removal of the original spa, shipping costs from the factory for the replacement spa and delivery and installation of the replacement will be your responsibility as the spa owner. The replacement spa will carry the balance of the original spa's warranty. Spa covers are not included.

This warranty ends either by specified time frame, owner-transfer, relocation, or installation of any component other than by manufacturer.

Warranty Limitations

This Limited Warranty is void if Cal Spas or its designated representative determines that the spa has been subjected to alteration, neglect, misuse or abuse, or freight damage caused by the common carrier; any repairs have been attempted by anyone other than a designated representative; the failure is caused by accident, acts of God or other causes beyond the control of the Manufacturer; neglect, misuse and abuse include any installation, operation or maintenance of the spa other than in accordance with the instructions contained in the owner's manual provided with the spa, including but not limited to the failure to maintain proper water chemistry and chemical balance and the use of abrasive or improper cleaners or non-genuine parts and accessories. This Limited Warranty does not provide coverage for any item attached to or installed on the spa after the date of manufacture or for gaining access to any component for repair or replacement. Spa units in commercial use are excluded from any coverage whatsoever. The spa owner accepts liability for repair work performed by anyone other than the Manufacturer or a designated Cal Spa representative.

Limitations

The Manufacturer disclaims all warranties, expressed or implied, in fact or in law, to the extent allowed by your State's Law, including the warranty of merchantability and fitness for use, except as stated specifically herein. All warranty service must be performed by the Manufacturer or its designated representative using authorized Cal Spa parts. No agent, dealer, distributor, service company or other party is authorized to change, modify or extend the terms of this limited warranty in any manner whatsoever. The Manufacturer will not be responsible for any statements or representations made in any form that go beyond, are broader than, or are inconsistent with any authorized literature or specifications furnished by Cal Spas.

Disclaimers

The Manufacturer and its representatives shall not be liable for any injury, loss, cost or other damage, whether incidental or consequential, arising out of any defect covered by this limited warranty, including without limitation, loss of use of the spa and cost for removal of defective product even if the Manufacturer was advised of the possibility of damage. The liability of the Manufacturer under this limited warranty, if any, shall not exceed the original amount paid for the defective product. Coverage under this limited warranty shall commence as of the original date of delivery and the duration of such coverage shall not extend for any reason whatsoever beyond the stated time periods. These disclaimers shall be equally applicable to any service provided by the Manufacturer and its designated representatives.

Legal Rights

This Limited Warranty gives you specific legal rights. You may also have other rights that vary from state to state. Some states do not allow limitations on how long an implied warranty lasts, so this limitation may not apply to you.

Warranty Registration

Registering your new Cal Spas product is quick and easy. It is important that you register your Cal Spas product as soon as possible. By taking just a few quick minutes to register, you can enjoy product alerts, more efficient support, and quicker service.

Go to www.calspas.com/warranty. Fill in your information and click "Send Warranty Info"

Locating the product serial number: The serial number of your spa is located on a metal plate attached to the inside of the door for the equipment area. You will need this number to properly register your spa and activate coverage. Write this information in the space provided below.

Spa Model: _____

Spa Serial Number: _____

Date Purchased: _____

Date Installed: _____

Dealer's Phone Number: _____

Dealer's Address: _____

Please visit www.quickspaparts.com to order your replacement parts.

LTR20161000, Rev. H
8/16/16